

INSPIRED FISHING

RISING WITH EVERY CHALLENGE

The average person might stumble upon a remote beach and find inspiration in the texture of the sand, curl of the waves and the salty spice of the air. For the community of anglers, however, playing witness to nature is far less satisfying than direct participation.

As we approach every piece of water, our attention inevitably falls to what lies beneath the surface: beneath the waves, off the point, on the edge of structure, at the intersection of currents. It's the fish and their habits, their power and speed that captivate our attention. Through rod and reel we find our connection. Some call it sport. We call it a way of life that's rich with experiences.

At Okuma Fishing Tackle, our goal is to enhance every encounter. Integrating the latest advancements in materials and construction techniques is a means to downplay the presence of the gear. Eliminate weight and increase feel. Enjoy a running fish instead of fearing it. Button down the drag and go toe-to-toe with complete confidence. Your focus is not on the equipment; it's on the fish.

Wherever your travels take you, from the local pond to distant reef, we're proud to be your partner in the discovery of what lies beneath.

OKUMA FISHING TACKLE CORPORATION



1 SPINNING REELS

- 15 Makaira Spinning
- 17 Cedros Spinning
- 20 Azores / Azores XP Spinning
- 22 Helios SX Spinning
- 23 Inspira Spinning
- 27 ITX Spinning
- 28 Epixor XT
- 29 Epixor LS
- 30 Ceymar
- 31 Ceymar XT
- 32 Avenger
- 33 Tomcat / Scorpio Spinning
- 34 Safina Pro / Safina
- 35 Solaris / Alaris
- 36 Altera / Jaw
- 37 C-Fight / Aria
- 38 Fuel Spin / Azaki
- 39 Pink Pearl V2 / Ceymar XT Mach FD
- 40 Carbonite V2 Match / Custom Black Feeder
- 41 Carbonite XP Feeder / Carbonite Match
- 42 Carbonite / Revenger Pro
- 43 Revenger / Cascade
- 44 Aventa Baitfeeder / Coronado CDX
- 45 Avenger Baitfeeder / Tomcat Baitfeeder
- 46 Longbow XT Baitfeeder / Ceymar Baitfeeder
- 47 Ceymar Baitfeeder / Pulzar Baitfeeder
- 48 Dyna Drag XP Baitfeeder / Powerliner Pro
- 49 Lotus Baitfeeder / AK Baitfeeder
- 50 Carbonite B-feeder / Carbonite XP Baitfeeder
- 51 Atomic Carp / Custom
- 52 LS Baitfeeder
- 54 8K Baitfeeder
- 56 Surf 8K Baitfeeder / Distance Surf Arena
- 57 Rockway / T-REX
- 58 Custom Black / Distance DTA
- 59 BIG BOMBER SPOD / INC

2 BAITCAST REELS

- 62 Komodo SS
- 63 Serrano / Ceymar
- 64 Scorpio / Fuel Spin
- 65 Citrix

3 TROLLING REELS

- 68 Tesoro
- 69 Cortez
- 70 Convector
- 71 Convector Line Counter
- 72 Convector LP Line Counter
- 73 Cold Water Line Counter
- 74 Cold Water Copper line reels
- 75 Magda Pro Line Counter
- 76 Classic Pro XPD
- 77 Classic Pro
- 78 Makaira TDC
- 82 Makaira
- 84 Makaira SEa
- 86 Makaira SEa Silver
- 88 Alijos
- 90 Cavalla
- 92 Solterra SLX

4 RODS

- 100 Helios Air
- 101 ONE.rod
- 102 Inspira
- 103 Helios SX Travel
- 104 Epixor
- 105 Epixor Travel / Ceymar SPR
- 106 Pink Pearl V2 / Azaki
- 107 Alaris
- 108 Altera
- 108 Alaria Spin
- 109 Altera Spin

- 110 Altera Travel
- 111 Altera Tele Spin / Vsysteem G2
- 112 Nemesis
- 113 Competition
- 114 Fuel Spin
- 115 Wave Power
- 116 Baltic Stick
- 117 Tactical
- 118 Red V1 / Red V2
- 119 Psycho Perch Spin
- 120 G-Control
- 121 LRF
- 122 Light Range Fishing
Light Range Fishing Tele Spin
- 123 Rodster Spin
- 124 Epixor / Competition Pole
- 125 G-power Tele Pole / G-power Travel Pole
- 126 Meridiana Bolo / Helios Bolo
- 127 Epixor Bolo / Competition Bolo
- 128 Tomcat
- 129 LS-8k Carp
- 130 8K Carp / LS-6K Carp
- 131 Custom Black Carp
- 132 C-Fight Carp
- 133 Avenger Carp
- 134 Longbow Carp / Altera Tele cast
- 135 8k Feeder
- 136 LS-6K Feeder
- 137 Custom Black Feeder
- 138 Ceymar Feeder / Okuma Feeder solid Tip
- 139 Custom Black Match / Ceymar Match Feeder
- 140 Makaira
- 142 PCH Custom
- 143 Okuma carbon butt / SLX
- 144 SLY Tuna Top Class
- 145 Cortez
- 146 Cold Water
- 147 Azores V2 Popping
- 148 Hawaiian Custom Popping
- 149 Metaloid S Popping
- 150 Metaloid Jigging
- 151 Tesoro Jigging

- 152 Metaloid Slow Jigging
- 153 Tesoro Slow Jigging
- 154 Azores Slow Jigging
- 155 Magda Air / Komodo Light Jigging
- 156 EGI Sniper / Epixor EGI
- 157 Aria EGI / Egipro
- 158 Flx Tip / Altera EGI
- 159 Altera EGI Tele / Tatakya Pro
- 160 Cold water / Cedros Surf
- 161 Azores XP / Azores II
- 162 Master Surf / Trio-Rex Arena
- 163 Trio-Rex Surf
- 164 Distance Surf Arena / Surfliner Surf
- 165 Nememsis Surf / Wave Power
- 166 Helios Tele Surf / Makaira Tele Surf
- 167 Azores Tele Surf / Trio-Rex Teel Surf
- 168 Ceymar Tele Surf / Avenger Tele Surf
- 169 Elettra Surf / Revenger Tele Surf
- 170 Fina Pro Tele Surf / Alaris Tele Surf
- 171 Wave Power Tele Surf

5 ROD AND REEL COMBOS

- 174 Fuel Spin
- 175 Steeler XP
- 176 Cascade II / Sierra
- 177 Fin-Chaser X

6 FLY, FLOAT AND MOOCHING

- 180 Raw-II / Aventa
- 181 Helios SX / SLV Fly

7 ACCESSORIES

- 184 Fishing Lines
- 188 Apparel & Accessories

CROSSOVER CONSTRUCTION

Innovation at its freshest...Trio spinning reels from Okuma feature a unique crossover construction. We took the best from aluminum construction and lightweight graphite materials and created a distinctive new concept in reel design. The solid one piece stamped aluminum reel stem and rotor arm are paired with lightweight graphite side plates and a rotor housing which provides strength where needed, and weight savings where possible.



SPINNING REEL DUAL FORCE DRAG

DFD incorporates both surfaces of the spool to maximize high-end drag pressure, efficiency and overall smoothness. Mounted in the top of the spool and protected by the Hydro Block system is a multi-disc felt drag system that works in conjunction with a secondary drag system that is mounted under the spool. Even pressure is applied to both surfaces of the spool for maximum stability.



LEVER DRAG DUAL FORCE DRAG

For extremely smooth and strong drag outputs, Okuma's Makaira lever drags are designed with a patented Dual Force Drag system. This drag system is specifically engineered to be mounted in the right side of the spool, designed around a Pull Bar Drag System which keeps all mechanical workings in precise alignment and places no pressure on the frame. This system works in conjunction with a custom designed thrust bearing, which alleviates side load at heavy drag settings.



C-40X

Okuma's C-40X carbon technology utilizes a specially blended graphite polymer. The carbon fibers in this material are elongated and reinforced, creating a substantially stronger composite than standard graphite materials. At 25% lighter, 1.5 times stronger and 100% anti-corrosive, C-40X translates into an extremely lightweight and durable construction.



TORSION CONTROL ARMOR

The Torsion Control Armor (TCA) design found on the new Inspria spinning reels is made with Okuma's C-40X long-strand carbon fiber technology. This not only makes the reel lighter, but also makes the reel extremely rigid which reduces twist and torque and keeps the internal parts in perfect alignment.



CENTRIFUGAL DISC BAIL

Okuma's Centrifugal Disc Bail (CDB) is a unique new design that incorporates a heavier brass disc that is perfectly weighted and balanced to create a smoother and easier bail operation, while increasing the strength and stability of the overall bail function.

CYCLONIC FLOW ROTOR

The Cyclonic Flow Rotor (CFR) was designed to create a "cyclonic" airflow, which significantly increases air flow through the ported rotor. This thoroughly tested design allows for a much faster drying time if the reel becomes wet, minimizing corrosion possibilities throughout the reel.



PRECISION ELLIPTICAL GEARING SYSTEM

The Precision Elliptical Gearing System advantage boils down to one thing and one thing only – performance. By regulating the speed of the spindle stroke, reels equipped with this system wind line more consistently and uniformly on the spool, resulting in level line lay. This creates less friction during casting for increased distance, greater accuracy, and longer line life, as well as smoother, more uniform drag pressures. Pick up any Okuma reel equipped with this feature and feel for yourself the balance, smoothness and power that are all characteristics of the Precision Elliptical Gearing System.



MCS

Okuma's Magnetic Control System is a fully-sealed, 100% waterproof cast control system that reduces backlash and improves casting distance by utilizing the magnetic field generated by the high RPM spinning of the spool during casting. The magnetic field is influenced by the adjustable cast control magnet which exerts an opposing force and allows for minute and accurate adjustments.



TECHNOLOGY FOR THE FUTURE

MACHINED RIGID FRAME

Okuma's Machined Rigid Frame construction incorporates a one-piece fully-machined aluminum frame. These rigid bar-stock aluminum frames are the ultimate in precision alignment and tolerances withstanding more pressure and torque than any other material used in our industry for frame materials. Okuma features these anodized frames on fly reels, baitcast reels, lever drag reels and star drag trolling reels.



BODY ARMOR

Okuma's stainless steel Body Armor eliminates the frame flex commonly found in graphite framed trolling reels. This feature incorporates two large stainless steel rings that are mounted to both sides of the frame. The harness lugs are integrated into the body armor design and eliminate the pressure commonly placed on the harness lugs by redistributing the pressure to these large-diameter rings.



SELF LUBRICATING GEAR SYSTEM

The self-lubricating gear system is a feature found on Okuma's higher-end star drag reels. The main gear on this system incorporates a heat-sensitive oil-impregnated brass bushing that is mounted in the center of the gear. This system releases oil if friction increases to keep the main gear and drive shaft running smoothly in all conditions. Okuma is the first company to adopt this technology which originated in the large machine industry where this function has been time tested for many years.



XL GEARING

The XL gearing design found on both lever drag and star drag reels incorporates an oversized gear box that features an enlarged gearing system and enlarged drag system. The drag surface areas on this system are more than 50% larger than a standard gear-box design. For the gear system, the major advantage is that the gear teeth are substantially larger, allowing more strength and cranking power. This is how we are able to offer a high-speed gear ratio reel without sacrificing cranking power. Our XL gearing system essentially turns your reel into a winch.



SPEED LOC PINION GEAR SYSTEM

The SLG technology incorporates a dual-step pinion gear system on star drag reels that allows positive engaging at extreme high speeds. The SLG system allows for instant gear engagement when engaging from freespool to strike at speeds in excess of 50 MPH.



MSS

Strong, Stable, Smooth - Okuma's Mechanical Stabilizing System is a support system that ties the spool shaft, pinion gear, pinion gear bearing, drive shaft and main gear together with a single support system. While other reels on the market offer minimal or no gear stabilization, this patented Okuma design allows all of these critical parts to stay in precise alignment. Designed specifically to hold up to the demands of braided and wire line fishing, the MSS support system stabilizes the spool shaft at 3 key stress points to eliminate flex under pressure - which directly translates into a reel that is more durable, stronger and smoother than the competition.



WIDE MOUTH LEVELWIND

This heavy-duty, stainless steel levelwind is Titanium coated and built to withstand the punishment of braided and wire lines. The guide has been designed with an increased opening to insure proper knot clearance when fishing with double lines. This wide space allows for Albright or similar connection knots, as well as swivels and copper line to pass through the guide easier and be wound directly on the spool.



T-BAR HANDLE

T-Bar Handle: The patented design of the T-Bar handle offers a true ergonomically correct angle to ensure an angler gets maximum power with minimum fatigue. The T-bar takes full advantage of the natural dynamics of the human hand, wrist and forearm to help sustain power and endurance for the angler.



STRIKE ZONE

Okuma's Strike Zone linecounter system incorporates a mechanical counter that precisely measures line based on spool revolutions. These counters measure in feet and are calibrated at the factory to be most accurate with a full spool and monofilament lines.



ERGO GRIP

The Ergo Grip handle knob is an extremely comfortable oversized handle-knob design for both speed and power. This soft-touch knob has been ergonomically designed to fit in the palm of your hand and will be found on certain Okuma lever drag reels, star drag reels and some spinning reel models.



2-SPEED GEARING

Okuma's 2-speed technology incorporates two sets of stainless steel main and pinion gears, allowing anglers the option of a high-speed gear ratio or a powerful low-speed gear ratio for maximum power and torque. To shift gears it is as easy as pushing a button or popping a lever with Okuma's unique shifting design to obtain the appropriate gear ratio you desire.



HIPPO GRIP

The Hippo Grip is a unique reel-clamp design that serves triple duty when fishing offshore. This heavy-duty, forged aluminum reel clamp securely supports your reel to the rod for maximum safety. This clamp also incorporates a small hole that was designed to be used with a safety line for trolling. On the rear of the clamp is a large diameter hole that was designed to be used as a trigger. The large hole should be mounted facing the butt of the rod.



CRC

Corrosion Resistant Coating combines Okuma's proprietary HDG-II gearing system, which offers exceptional anti-corrosive properties compared to standard gears, with a coating of Corrosion X HD to all internal and external parts. The CRC process actually penetrates and bonds to the metal, which helps significantly toward long term protection.



TECHNOLOGY FOR THE FUTURE



BAITFEEDING SYSTEM

Okuma's patented baitfeeding system allows anglers to disengage their spinning reel spool and allow their bait to run freely. The baitfeeding system incorporates a secondary micro-adjustable drag system at the rear of the reel that allows for precise adjustment of the spool for bait control. In order to disengage this system simply turn the handle. The On/Off lever on the rear of the reel will automatically disengage the baitfeeding system so you can fight your fish with the main drag system.

With today's super braided lines and lighter more compact reels, ALG offers anglers lighter weight gears without compromising on strength and durability. Adding to their longevity, ALG gears are anodized to hold up to the elements much better than traditional gearing materials.

ALG



HDGII

Okuma's proprietary High Density Gearing II incorporates an extremely strong alloy composition with a special anti-corrosion coating process. The result is high density, corrosion resistant gears that are built to handle the severe elements and brutal strains placed on a reel's internal gear system.

QUICK-SET

This system allows for instant handle engagement and eliminates all handle back play commonly found in many reels. This is accomplished by using a corrosion-resistant stainless steel roller bearing that engages the reel in one direction for rock-solid hook sets.



ALUMILITE FRAME CONSTRUCTION

AlumiLite construction incorporates Okuma's rigid aluminum body technology on spinning, trolling and fly reel designs. Aluminum frames are stronger and more rigid and are capable of withstanding more pressure and torque than traditional graphite frames. These lightweight, diecast aluminum frames provide more precise tolerances for precision gear alignment, maximum castability and ultimate durability.

RES II

The RES II System stands for Rotor Equalizing System. This second-generation RES System incorporates a computer-balanced weight precisely placed in the rotor. This weight allows for precision balance and eliminates all spool wobble for perfect alignments and smooth cranking.



HYDRO BLOCK

The Hydro Block design features a rubber gasket mounted in the top of a spinning reel spool. This rubber seal blocks water and foreign materials from entering the drag system. The Hydro Block system ensures that your drag washers always perform at optimal levels.

The Even Flow Roller System utilizes a ball bearing under the line roller to maximize efficiency. This roller helps reduce line twists by freely rolling over the line roller without friction. Without this system, line will naturally twist when drag is pulled.

EFR II



HIGH PERFORMANCE BALL BEARINGS

The balls used on the HPB's are constructed from the same high-grade stainless steel material as the bearing housing. These bearings were designed to be more than 10 times more resistant to saltwater than standard stainless steel bearings. These bearings may even outlast the angler himself.



Okuma's Magnetic Control System reduces backlash and improves casting distance by utilizing the magnetic field generated by the high RPM spinning of the spool during casting. The magnetic field is influenced by the adjustable cast control magnets which exert an opposing force and allows for minute and accurate adjustments.

MCS



VELOCITY CONTROL

The Velocity Control System is an adjustable, 6-pin centrifugal braking system for precision spool control. Weights can be adjusted IN or OUT for additional spool control. Positioning the weights toward the spool allows for more freespool, while adjusting the pins out away from the spool allows for more control. Anglers can alternate weights until they find that perfect balance for casting.



SPOOL ACCESS PORT

This unique new design can be found on Okuma's low profile baitcast reels. The Spool Access Port allows for quick access to the spool by simply sliding the lock/unlock lever on the side plate opposite the handle. This system allows for quick spool changes, but more importantly it allows quick access for adjusting the Velocity Control System.





SPINNING REELS

Spinning reels are an opportunity. Worldwide, they're most often the very first reel a beginning angler picks up, and for so many, they're the only reel type that's ever needed. As such, spinning reels define the experience from pond panfish to offshore big game. At every level the Okuma selection is angler-centric, delivering a fantastic fishing experience through better design, materials and construction techniques. Our reels need to inspire participation today, tomorrow and in the future ahead, a responsibility we gladly accept.

The image is a composite. The left side shows a close-up of a large, multi-tiered stainless steel gear assembly, likely a main gear, with several smaller gears visible in the background. The right side shows a welder wearing a protective mask and gloves, working on a metal component in a dark industrial setting, with bright sparks and light from the welding process. The MAXGEAR logo is overlaid on the left side.

MAXGEAR

MAXGEAR REACH FOR THE MAX

Okuma's Makaira spinning reels are in a class of their own, featuring a forged stainless steel, machined MAXGEAR. While the majority of reels in this category feature bronze, aluminum or simple machine cut stainless steel gears, the Makaira's class leading main gears are machine cut forged stainless steel. We ported the main gear and incorporated other design elements to keep it light weight enough for you to fish all day. No compromises were made in the internal design of MAXGEAR. The pinion gear and heat treated spool shaft are 17-4 grade machine cut stainless steel. They are rust proof and were optimized to work with braided line and the reels high-output drag.



MAKAIRA[®] SPINNING REEL

Derived from the Okuma 4D Concept which focuses on Design, Drive, Drag and Durability as core performance elements, Makaira spinning reels are built from the ground up to be the toughest, most durable spinning reels an angler can own. Constructed from the finest and strongest materials available, Makaira series reels are big game reels developed to pursue everything from Giant Trevally, trophy-sized Yellowtail and Amberjack, to the most formidable adversaries in the ocean, like giant Bluefin Tuna, Marlin, cow Yellowfin Tuna and large sharks.



MAXGEAR

Makaira reels feature a forged, machine cut stainless steel main gear paired with a 17-4 stainless steel pinion gear. This gear system is unmatched in this category.



The Makaira is unmatched in elite level spinning reels with a forged, machine cut aluminum body, sideplate and rotor. There are no die-cast parts on this reel. The Mak is the elite reel in the category, with a complete forged aluminum housing.



BEARINGS

CARBON FIBER

The Makaira drag system utilizes the complete surface area of the carbon fiber drag washers; the system has been engineered to make full contact with the outer edges of our carbon washers, which maximizes efficiency and the ability to deliver high drag outputs. The DFD concept applies pressure to both sides of the spool in order to maximize use of the available surface area, enlarging the working surfaces of our drag system, and dramatically improving heat dissipation.

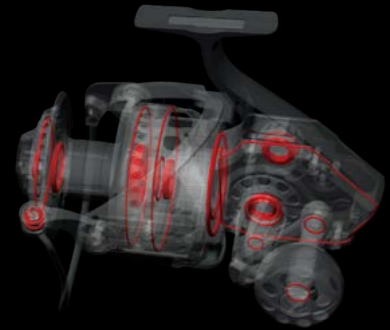

Makaira spinning reels are engineered to withstand the most brutal conditions the ocean can offer. To accomplish this, we equipped this series with 23 different oil-retaining o-rings and gaskets. Our engineers made this reel impervious to the elements, and by making it water tight, all the internal mechanisms are sealed and protected from salt. The result is the best-of-the-best when it comes to big game fishing reels.

MAKAIRA[®] SPINNING REEL

MAKAIRA SPINNING REELS FEATURE:

- Forged aluminum, machine cut body/sideplate
- Forged aluminum, machine cut Cyclonic Flow rotor
- Forged stainless steel main gear for ultimate power and strength
- Precision machine cut 17-4 grade stainless steel pinion gear
- Oversized 17-4 grade stainless steel spool shaft reduces flex
- Hydro Sealed Body and DFD system for maximum protection
- Carbonite high output drag with Cal's drag grease on full DFD
- Customized pre-set drag system, works like a lever drag reel
- 9HPB + 1RB corrosion resistant stainless steel bearings
- Dual anti-reverse system for maximum strength and reliability
- Quick-Set stainless steel German anti-reverse roller bearing
- CRC: Corrosion-resistant coating process
- Machined aluminum, 2-tone anodized spool with LCS lip
- Machined aluminum screw-in handle arm for added strength
- Right and Left handles are designed differently: Order by Rt/Lt
- Heavy duty, solid aluminum bail wire with manual trip function
- Rotor brake system works in conjunction with manual bail trip
- Machined aluminum handle knob: Custom options available



MK-30000LS
(Left Hand Model)



MK-10000R
(Right Hand Model)



MK-20000LS
(Left Hand Model)



MAKAIRA SPINNING

Model	Gear ratio	Bearings	Weight (g)	Line retrieve (cm)	Max Drag Force (kg)	Monofilament line capacity (diameter in mm.)	Frame	Side plates	Rotor	Spool
Left handed High-speed spinning reels										
MK-10000L	4.9:1	9 + 1	810	101.6	25	0.35/380, 0.40/300, 0.45/225	AL	AL	AL	AL
MK-20000LS	5.8 : 1	9 + 1	997	131.1	30	0.45/450, 0.50/370, 0.55/300	AL	AL	AL	AL
MK-30000LS	5.8 : 1	9 + 1	1107	166.9	30	0.55/530, 0.60/450, 0.65/380	AL	AL	AL	AL
Right handed High-speed spinning reels										
MK-10000R	4.9:1	9 + 1	810	101.6	25	0.35/380, 0.40/300, 0.45/225	AL	AL	AL	AL
MK-20000RS	5.8:1	9 + 1	997	131.1	30	0.45/450, 0.50/370, 0.55/300	AL	AL	AL	AL
MK-30000RS	5.8:1	9 + 1	1107	166.9	30	0.55/530, 0.60/450, 0.65/380	AL	AL	AL	AL

INSPIRED BY LIGHTWEIGHT



CEDROS

CEDROS SPINNING REELS FEATURE:

- DFD: Precision Dual Force Drag system
- Multi-disc drag adjustment for more precise settings
- LITECAST: Body construction is 15% lighter
- CRC: Corrosion resistant coating process
- 6HPB + 1RB corrosion resistant stainless steel bearings
- Dual anti-reverse feature on 8000-14000 sizes
- Quick-Set anti-reverse roller bearing
- Manual bail trip function 8000-14000 sizes
- HDGI: Corrosion resistant, High density gearing
- Precision machine cut brass pinion gear
- Machined aluminum, 2-tone anodized spool
- Machined aluminum, screw-in handle arm



CEDROS SPINNING

	Model	Gear ratio	Bearings	Weight (g)	Line retrieve (cm)	Max Drag Force (kg)	Monofilament line capacity (diameter in mm.)	Frame	Side plates	Rotor	Spool
NEW	CJ-4000H	5.8:1	6+1	380	90	15	0.25/280, 0.30/185, 0.35/130	LC	LC	LC	AL
NEW	CJ-5000H	5.8:1	6+1	397	95	15	0.30/240, 0.35/170, 0.40/125	LC	LC	LC	AL
NEW	CJ-6000H	5.8:1	6+1	405	101	15	0.30/315, 0.35/220, 0.40/165	LC	LC	LC	AL
NEW	CJ-8000	5.4:1	6+1	624	104	20	0.40/230, 0.45/180, 0.50/140	LC	LC	LC	AL
NEW	CJ-10000	5.4:1	6+1	643	112	20	0.40/290, 0.45/220, 0.50/175	LC	LC	LC	AL
NEW	CJ-14000	5.4:1	6+1	646	116	20	0.40/370, 0.45/290, 0.50/230	LC	LC	LC	AL



MAG-ALLOY CONSTRUCTION DESIGN

Okuma's LITECAST construction design is 15% lighter than former Azores reels while maintaining maximum strength and durability.

DUAL FORCE DRAG SYSTEM

DFD incorporates both surfaces of the spool to maximize high-end drag pressure, efficiency and overall smoothness. Mounted in the top of the spool and protected by the Hydro Block system is a multi-disc felt drag system that works in conjunction with a secondary drag system that is mounted under the spool. Even pressure is applied to both surfaces of the spool for maximum stability and significantly increased drag output compared to traditional single drag systems.



CEDROS

Saltwater Spinning Reel



HIGH PERFORMANCE BEARING (HPB)

6 high performance ball bearings provide Cedros with outstanding smoothness and reliability in saltwater fishing environments. The balls used on the HPB's are constructed from the same high-grade stainless steel material as the bearing housing.

GEARING STABILIZATION DESIGN

Ultimate pinion stability for perfect main gear adjustment : super smooth gearing feeling and high durability.

MANUAL BAIL TRIP

Manual bail trip function for both reliability as well as reduces line twists.



AZORES BLUE SALTWATER SPINNING REELS FEATURE:

- DFD: Precision Dual Force Drag system
- Precision click drag adjustment for more precise settings
- Multi-disc, Carbonite and felt drag washers for DFD
- 6HPB + 1RB corrosion resistant stainless steel bearings
- Quick-Set anti-reverse roller bearing plus ratchet system
- Dual anti-reverse system for maximum security
- Precision machine cut brass pinion gear
- CRC: Corrosion-resistant coating process
- HDGII: Corrosion-resistant, High density gearing
- ALC: Rigid diecast aluminum body, sideplate and rotor
- MSS: carbon Mechanical Stabilizing System
- Machined aluminum, 2-tone anodized spool with LCS lip
- Machined aluminum handle arm for added strength
- Hydro Block water tight drag seal
- Heavy duty, solid aluminum bail wire



AZORES-6500



AZORES

Model	Gear ratio	Bearings	Weight (g)	Line retrieve (cm)	Max Drag Force (kg)	Monofilament line capacity (diameter in mm.)	Frame	Sideplates	Rotor	Spool
Azores-4000	5.8:1	6+1	341	90.9	13	0.30/180, 0.35/135, 0.40/105	AL	AL	AL	AL
Azores-5500	5.8:1	6+1	524	104.6	13	0.35/250, 0.40/190, 0.50/125	AL	AL	AL	AL
Azores-6500	5.4:1	6+1	730	110.2	20	0.35/390, 0.40/300, 0.50/185	AL	AL	AL	AL
Azores-8000	5.4:1	6+1	748	120.4	20	0.45/310, 0.50/250, 0.55/210	AL	AL	AL	AL
Azores-9000	5.4:1	6+1	750	120.4	20	0.45/350, 0.50/280, 0.55/240	AL	AL	AL	AL



AZORES XP SPINNING REELS FEATURE:

- DFD: Precision Dual Force Drag system
- Precision click drag adjustment for more precise settings
- Multi-disc, Carbonite and felt drag washers for DFD
- 6HPB + 1RB corrosion resistant stainless steel bearings
- Quick-Set anti-reverse roller bearing plus ratchet system
- Dual anti-reverse system for maximum security
- Precision machine cut brass pinion gear
- CRC: Corrosion-resistant coating process
- HDGII: Corrosion-resistant, High density gearing
- ALC: Rigid diecast aluminum body, sideplate and rotor
- MSS: carbon Mechanical Stabilizing System
- Machined aluminum, 2-tone anodized spool with LCS lip
- Machined aluminum handle arm for added strength
- Hydro Block water tight drag seal
- Heavy duty, solid aluminum bail wire



ZXP-16000P



AZORES XP

Model	Gear ratio	Bearings	Weight (g)	Line retrieve (cm)	Max Drag Force (kg)	Monofilament line capacity (diameter in mm.)	Frame	Sideplates	Rotor	Spool
High-speed spinning reels										
NEW ZXP-4000H	5.8:1	6+1	335	91	13	0.25/290, 0.30/200, 0.35/150	AL	AL	AL	AL
NEW ZXP-6000H	5.8:1	6+1	526	105	13	0.30/300, 0.35/220, 0.40/170	AL	AL	AL	AL
NEW ZXP-8000H	5.4:1	6+1	720	110	20	0.40/250, 0.45/200, 0.50/160	AL	AL	AL	AL
NEW ZXP-14000H	5.4:1	6+1	738	120	20	0.40/370, 0.45/290, 0.50/240	AL	AL	AL	AL
NEW ZXP-16000H	5.4:1	6+1	740	120	20	0.40/420, 0.45/335, 0.50/270	AL	AL	AL	AL
Low-speed spinning reels										
NEW ZXP-6000P	4.8:1	6+1	526	87	13	0.30/300, 0.35/220, 0.40/170	AL	AL	AL	AL
NEW ZXP-8000P	3.8:1	6+1	720	77	20	0.40/250, 0.45/200, 0.50/160	AL	AL	AL	AL
NEW ZXP-14000P	3.8:1	6+1	738	84	20	0.40/370, 0.45/290, 0.50/240	AL	AL	AL	AL
NEW ZXP-16000P	3.8:1	6+1	740	84	20	0.40/420, 0.45/335, 0.50/270	AL	AL	AL	AL

Helios SX

HELIOS SX SPINNING REELS FEATURE:

- Light weight C-40X carbon frame and sideplates
- C-40X Cyclonic Flow Rotor for corrosion resistance
- TCA: Torsion Control Armor reduces twisting
- 8HPB + 1RB corrosion resistant stainless steel bearings
- Quick-Set anti-reverse roller bearing
- Precision machine cut brass pinion gear
- ALG: Precision AlumLite alloy main gear and oscillating gears
- Rigid, machined aluminum, anodized handle

- Light weight, EVA handle knobs for comfort
- Precision Elliptical Gearing system
- Machined aluminum, 2-tone anodized spool
- Heavy duty, solid aluminum bail wire
- RESII: Computer balanced Rotor Equalizing System
- Metal line clip
- LCS line control spool



HSX-40



HSX-40



CYCLONIC FLOW ROTOR

The Cyclonic Flow Rotor (CFR) was designed to create a "cyclonic" airflow, which significantly increases air flow through the ported rotor. This thoroughly tested design allows for a much faster drying.



TORSION CONTROL ARMOR

The Torsion Control Armor (TCA) design found on the new Inspira spinning reels is made with Okuma's C-40X long-strand carbon fiber technology. This not only makes the reel lighter, but also makes the reel extremely rigid which reduces twist and torque and keeps the internal parts in perfect alignment.

HELIOS SX SPINNING



Model	Gear ratio	Bearings	Weight (g)	Line retrieve (cm)	Max Drag Force (kg)	Monofilament line capacity (diameter in mm.)	Frame	Sideplates	Rotor	Spool
Standard speed spinning reels										
HSX-20	5.0:1	8+1	180	60.7	3	0.15/240, 0.20/140, 0.25/90	C-40X	C-40X	C-40X	AL
HSX-30	5.0:1	8+1	202	68.6	6	0.20/300, 0.25/200, 0.30/130	C-40X	C-40X	C-40X	AL
HSX-40	5.0:1	8+1	262	76.2	6	0.25/260, 0.30/180, 0.35/130	C-40X	C-40X	C-40X	AL
High-speed spinning reels										
HSX-40S	5.8:1	8+1	260	91.2	6	0.25/260, 0.30/180, 0.35/130	C-40X	C-40X	C-40X	AL

Inspira

INSPIRA SPINNING REELS FEATURE:

- Light weight C-40X carbon frame and sideplates
- 8BB + 1RB stainless steel bearings
- Quick-Set anti-reverse roller bearing
- Precision machine cut brass pinion gear
- Rigid, forged aluminum, anodized handle
- Light weight, EVA handle knobs for comfort
- Precision Elliptical Gearing system
- Machined aluminum, 2-tone anodized spool
- Heavy duty, solid aluminum bail wire
- CFR: Cyclonic Flow Rotor



ISX-30R



ISX-40B



INSPIRA

Model	Gear ratio	Bearings	Weight (g)	Line retrieve (cm)	Max Drag Force (kg)	Monofilament line capacity (diameter in mm.)	Frame	Sideplates	Rotor	Spool
Inspira Red version with C-40X finish										
ISX-20R	5.0:1	8+1	182	60.7	3	0.15/240, 0.20/140, 0.25/90	C-40X	C-40X	GR	AL
ISX-30R	5.0:1	8+1	213	68.6	6	0.20/300, 0.25/200, 0.30/130	C-40X	C-40X	GR	AL
ISX-40R	5.0:1	8+1	268	76.2	6	0.25/260, 0.30/180, 0.35/130	C-40X	C-40X	GR	AL
Inspira Blue version with C-40X finish										
ISX-20B	5.0:1	8+1	182	60.7	3	0.15/240, 0.20/140, 0.25/90	C-40X	C-40X	GR	AL
ISX-30B	5.0:1	8+1	213	68.6	6	0.20/300, 0.25/200, 0.30/130	C-40X	C-40X	GR	AL
ISX-40B	5.0:1	8+1	268	76.2	6	0.25/260, 0.30/180, 0.35/130	C-40X	C-40X	GR	AL



TORSION CONTROL ARMOR DOMINATE WITH POWER

Okuma's Torsion Control Armor (TCA) is a breakthrough in reel design that provides a stronger, more durable, reel construction. TCA technology offers maximum stability by eliminating reel stem twisting and keeping gears aligned; giving the confidence you need in fighting the fish of a lifetime.

Strengthen Against Weak Points

While traditional spinning body designs utilize single-side support, Torsion Control Armor uses a durable double-arm design to help decrease pressure from weak areas and body twisting points.

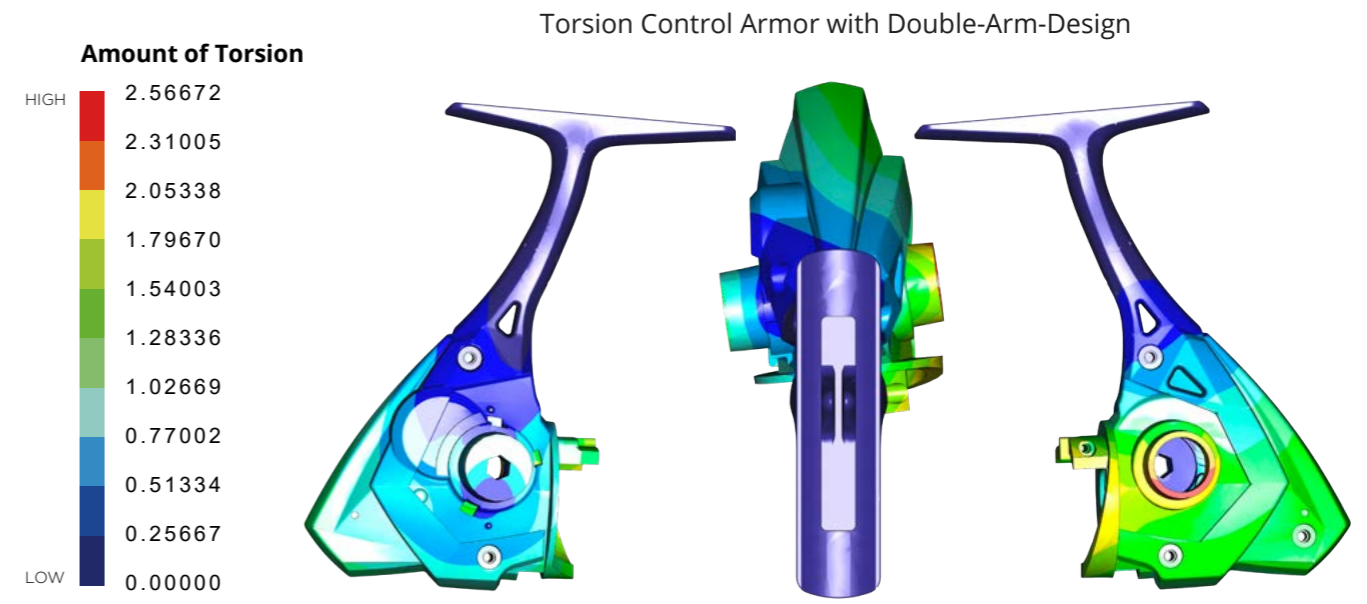
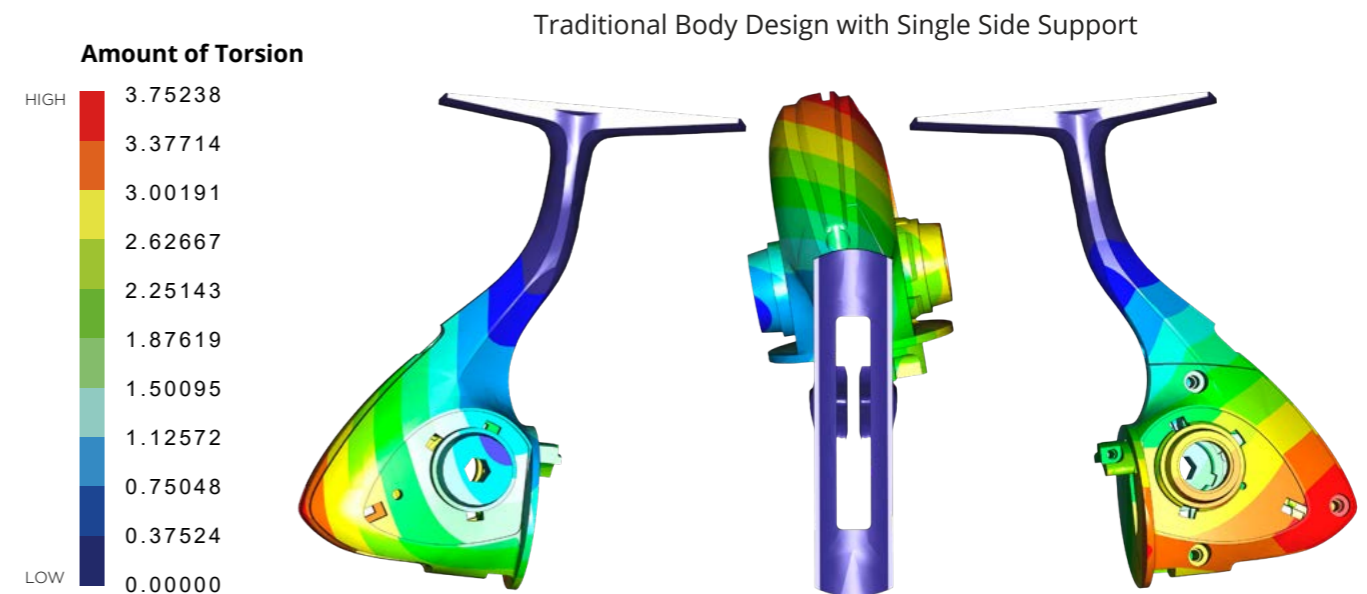

INSPIRED BY POWER

MACHINED ALUMINUM SCREW IN HANDLE DESIGN WITH TGT GRIP

The machined aluminum handle screws directly into the reel for the ultimate in a direct and secure connection.
(TGT: Traction Grip Technology)

LIGHTWEIGHT AND RIGID C-40X CARBON TCA AND ROTOR

The lightweight and rigid C-40X long strand carbon fiber is featured in TCA and rotor to give and provide extra strength where it is needed the most.



ITX

ITX CARBON SPINNING REELS FEATURE:

- Lightweight and rigid C-40X carbon TCA and rotor
- Multi-disc, carbon fiber drag system with Hydro Block gasket
- 7HPB + 1RB High Performance, grease packed bearings
- Quick-Set anti-reverse roller bearing
- CFR: Cyclonic Flow Rotor Technology
- Machined aluminum screw in handle design
- TGT Grip: Traction Grip Technology
- High speed on all models
- Precision machine cut brass pinion gear
- Machined aluminum, 2-tone anodized aluminum spool
- Heavy duty, solid aluminum bail wire
- RESII: Computer balanced Rotor Equalization System



ITX CARBON

	Model	Gear ratio	Bearings	Weight (g)	Line retrieve (cm)	Max Drag Force (kg)	Monofilament line capacity (diameter in mm.)	Frame	Sideplates	Rotor	Spool
High-Speed spinning reels											
NEW	ITX-1000H	5.8:1	7+1	200	73	3	0.15/250, 0.20/140, 0.25/90	GR	GR	C-40X	AL
NEW	ITX-2500H	6.0:1	7+1	235	85	8	0.20/250, 0.25/165, 0.30/110	GR	GR	C-40X	AL
NEW	ITX-3000H	6.0:1	7+1	235	85	8	0.20/300, 0.25/200, 0.30/130	GR	GR	C-40X	AL
NEW	ITX-4000H	6.0:1	7+1	285	94	10	0.25/260, 0.30/180, 0.35/130	GR	GR	C-40X	AL
Standard Speed spinning reels											
NEW	ITX-1000	5.0:1	7+1	200	61	3	0.15/250, 0.20/140, 0.25/90	GR	GR	C-40X	AL
NEW	ITX-2500	5.0:1	7+1	235	69	8	0.20/250, 0.25/165, 0.30/110	GR	GR	C-40X	AL
NEW	ITX-3000	5.0:1	7+1	235	69	8	0.20/300, 0.25/200, 0.30/130	GR	GR	C-40X	AL
NEW	ITX-4000	5.0:1	7+1	285	76	10	0.25/260, 0.30/180, 0.35/130	GR	GR	C-40X	AL

EPIXOR XT

EPIXOR XT SPINNING REELS FEATURE:

- TCA: C40x carbon Torsion Control Armor reduces twisting
- Multi-disc, Japanese oiled felt drag washers
- 7BB+1RB stainless steel bearings
- Quick-Set ant-reverse bearing
- Precision machine cut brass pinion gear
- Slow oscillation system for improved line lay
- Corrosion resistant graphite body and rotor
- CFR: Cyclonic Flow Rotor technology
- Rigid metal handle design for strength
- Machined aluminum, 2-tone anodized spool with LCS lip
- Heavy duty solid aluminum bail wire
- RESII: Computer balanced Rotor Equalizing System



EPXT-55



EPXT-30



(By order-Shallow Spool)

EPIXOR XT SHALLOW SPOOL

Model	PE line capacity (diameter in mm.)
Shallow Spool	
EPXT-20M	PE0.6 (0.128mm) / 150M ; PE0.8 (0.148mm) / 100M ; PE1.0 (0.165mm) / 85M
EPXT-30M	PE0.6 (0.128mm) / 250M ; PE0.8 (0.148mm) / 150M ; PE1.0 (0.165mm) / 130M
EPXT-40M	PE1.0 (0.165mm) / 170M ; PE1.2 (0.185mm) / 150M ; PE1.5 (0.205mm) / 120M
EPXT-55M	PE2.0 (0.235mm) / 210M ; PE2.5 (0.260mm) / 180M ; PE3.0 (0.285mm) / 150M

EPIXOR XT

Model	Gear ratio	Bearings	Weight (g)	Line retrieve(cm)	Max Drag Force (kg)	Monofilament line capacity (diameter in mm.)	Frame	Sideplates	Rotor	Spool
<div style="display: flex; justify-content: space-around; align-items: center;"> CFR CYCLONIC FLOW ROTOR 50 SLOW OSCILLATION 4G Torsion Control Armor HDS </div>										
EPXT-20	5.0:1	7+1	208	61	5	0.15/250, 0.20/140, 0.25/90	C-40X	GR	GR	AL
EPXT-30	5.0:1	7+1	249	69	8	0.20/300, 0.25/200, 0.30/130	C-40X	GR	GR	AL
EPXT-40	5.0:1	7+1	304	76	10	0.25/260, 0.30/180, 0.35/130	C-40X	GR	GR	AL
EPXT-55	5.0:1	7+1	316	87	12	0.30/300, 0.35/220, 0.40/170	C-40X	GR	GR	AL
High-speed spinning reels										
EPXT-30S	6.0:1	7+1	255	85	8	0.20/300, 0.25/200, 0.30/130	C-40X	GR	GR	AL
EPXT-40S	6.0:1	7+1	310	94	10	0.25/260, 0.30/180, 0.35/130	C-40X	GR	GR	AL

EPIXOR LS

EPIXOR LS SPINNING REELS FEATURE:

- TCA: C40x carbon Torsion Control Armor reduces twisting
- Multi-disc, Japanese oiled felt drag washers
- 5BB+1RB stainless steel bearings
- Quick-Set ant-reverse bearing
- Precision machine cut brass pinion gear
- Slow oscillation system for improved line lay
- Corrosion resistant graphite body and rotor
- CFR: Cyclonic Flow Rotor technology
- Rigid metal handle design for strength
- Machined aluminum, 2-tone anodized spool with LCS lip
- Heavy duty solid aluminum bail wire
- RESII: Computer balanced Rotor Equalizing System



EPL-55



EPL-30



(By order-Shallow Spool)

EPIXOR LS SHALLOW SPOOL

Model	PE line capacity (diameter in mm.)
Shallow Spool	
EPL-20M	PE0.6 (0.128mm) / 150M ; PE0.8 (0.148mm) / 100M ; PE1.0 (0.165mm) / 85M
EPL-30M	PE0.6 (0.128mm) / 250M ; PE0.8 (0.148mm) / 150M ; PE1.0 (0.165mm) / 130M
EPL-40M	PE1.0 (0.165mm) / 170M ; PE1.2 (0.185mm) / 150M ; PE1.5 (0.205mm) / 120M
EPL-55M	PE2.0 (0.235mm) / 210m ; PE2.5 (0.260mm) / 180M ; PE3.0 (0.285mm) / 150M

EPIXOR LS

Model	Gear ratio	Bearings	Weight (g)	Line retrieve (cm)	Max Drag Force (kg)	Monofilament line capacity (diameter in mm.)	Frame	Sideplates	Rotor	Spool
<div style="display: flex; justify-content: space-around; align-items: center;"> CFR CYCLONIC FLOW ROTOR 50 SLOW OSCILLATION 4G Torsion Control Armor HDS </div>										
EPL-20	5.0:1	5+1	216	61	5	0.15/250, 0.20/140, 0.25/90	C-40X	GR	GR	AL
EPL-30	5.0:1	5+1	258	69	8	0.2/300, 0.25/200, 0.3/130	C-40X	GR	GR	AL
EPL-40	5.0:1	5+1	315	76	10	0.25/260, 0.30/180, 0.35/130	C-40X	GR	GR	AL
EPL-55	5.0:1	5+1	327	87	12	0.30/300, 0.35/220, 0.40/170	C-40X	GR	GR	AL
High-speed spinning reels										
EPL-30S	6.0:1	5+1	264	85	8	0.20/300, 0.25/200, 0.30/130	C-40X	GR	GR	AL
EPL-40S	6.0:1	5+1	320	94	10	0.25/260, 0.30/180, 0.35/130	C-40X	GR	GR	AL



Ceymar XT

CETMAR XT REELS FEATURE:

- Multi-disc, Japanese oiled felt drag system
- 7BB+1RB for ultimate smoothness, 6BB+1RB on size 10
- Quick-Set anti-reverse roller bearing
- Precision machine cut brass pinion gear
- Corrosion-resistant graphite body
- Rigid, forged zinc, black anodized handle design
- Light weight, TPE handle knobs for comfort
- Precision Elliptical Gearing system
- Machined aluminum, 2-tone anodized spool
- Heavy duty, solid aluminum bail wire
- RESII: Computer balanced Rotor Equalizing System
- Line control system on the spool for better line casting
- Alum handle with EVA knob
- Plastic line clip
- Spare aluminum spool

Ceymar

CEYMAR SPINNING REELS FEATURE:

- Multi-disc, oiled felt drag system
- 7 BB + 1RB for ultimate smoothness, 6BB+1RB on size 10
- Quick-Set anti-reverse roller bearing
- Precision machine cut brass pinion gear
- Corrosion-resistant graphite body
- Rigid, forged zinc, black anodized handle design
- Light weight, EVA handle knobs for comfort
- C-65 models feature ergo grip handle style
- Precision Elliptical Gearing system
- Machined aluminum, 2-tone anodized spool
- Heavy duty, solid aluminum bail wire
- RESII: Computer balanced Rotor Equalizing System
- Narrow Blade Body Design for reduced fatigue
- Line control system on the spool for better line-lay



CEYMAR

Model	Gear ratio	Bearings	Weight (g)	Line retrieve(cm)	Max Drag Force (kg)	Monofilament line capacity (diameter in mm.)	Frame	Sideplates	Rotor	Spool
C-10	5.0:1	6+1	170	55.4	3	0.10/260, 0.14/150, 0.16/115	GR	GR	GR	AL
C-20	5.0:1	6+1	190	61	3	0.15/250, 0.20/140, 0.25/90	GR	GR	GR	AL
C-25	5.0:1	7+1	227	65.5	7	0.15/295, 0.20/170, 0.25/110	GR	GR	GR	AL
C-30	5.0:1	7+1	232	65.5	7	0.20/200, 0.25/130, 0.30/100	GR	GR	GR	AL
C-35	5.0:1	7+1	269	76.2	8	0.25/195, 0.30/135, 0.35/100	GR	GR	GR	AL
C-40	5.0:1	7+1	283	76.2	8	0.25/240, 0.30/170, 0.35/125	GR	GR	GR	AL
C-55	4.5:1	7+1	403	79.0	15	0.30/325, 0.35/240, 0.40/185	GR	GR	GR	AL
C-65	4.8:1	7+1	586	97.3	16	0.35/340, 0.40/260, 0.50/160	GR	GR	GR	AL
Ceymar High Speed										
NEW C-30S	6.2:1	7+1	226	84	7	0.20/260, 0.25/170, 0.30/120	GR	GR	GR	AL
NEW C-40S	6.2:1	7+1	298	97.4	8	0.25/290, 0.30/200, 0.35/150	GR	GR	GR	AL

CEYMAR XT

Model	Gear ratio	Bearings	Weight (g)	Line retrieve (cm)	Max Drag Force (kg)	Monofilament line capacity (diameter in mm.)	Frame	Sideplates	Rotor	Spool	Extra Spool
Ceymar XT -Front Drag											
CXT-10	5.0:1	6+1	170	55.4	3	0.10/260, 0.14/150, 0.16/115	GR	GR	GR	AL	AL
CXT-20	5.0:1	6+1	196	61	3	0.15/250, 0.20/140, 0.25/90	GR	GR	GR	AL	AL
CXT-25	5.0:1	7+1	227	65.5	7	0.15/295, 0.20/170, 0.25/110	GR	GR	GR	AL	AL
CXT-30	5.0:1	7+1	232	65.5	7	0.20/200, 0.25/130, 0.30/100	GR	GR	GR	AL	AL
CXT-35	5.0:1	7+1	269	76.2	8	0.25/195, 0.30/135, 0.35/100	GR	GR	GR	AL	AL
CXT-40	5.0:1	7+1	283	76.2	8	0.25/240, 0.30/170, 0.35/125	GR	GR	GR	AL	AL
CXT-55	4.5:1	7+1	403	79.0	15	0.30/325, 0.35/240, 0.40/185	GR	GR	GR	AL	AL
CXT-65	4.8:1	7+1	586	97.3	16	0.35/340, 0.40/265, 0.50/160	GR	GR	GR	AL	AL
Ceymar XT -Rear Drag											
CXTR-30	5.0:1	7+1	232	65.5	7	0.20/200, 0.25/130, 0.30/100	GR	GR	GR	AL	AL
CXTR-40	5.0:1	7+1	283	76.2	8	0.25/240, 0.30/170, 0.35/125	GR	GR	GR	AL	AL

AVENGER

AVENGER REELS FEATURE:

- Multi-disc, Japanese oiled felt drag system
- 6BB + 1RB for ultimate smoothness and performance
- Quick-Set anti-reverse roller bearing
- Precision machine cut brass pinion gear
- Corrosion resistant graphite body and rotor
- CFR: Cyclonic Flow Rotor technology
- Precision Elliptical Gearing system



AV-3000LE



AV-3000



AV-8000



AVENGER

Model	Gear ratio	Bearings	Weight (g)	Line retrieve(cm)	Max Drag Force(kg)	Monofilament line capacity (diameter in mm.)	Frame	Sideplates	Rotor	Spool
Avenger Spinning Reels										
AV-500a	5.0:1	6+1	175	55	3	0.15/145, 0.20/80, 0.25/50	GR	GR	GR	AL
AV-1000a	5.0:1	6+1	195	61	3	0.15/250, 0.20/140, 0.25/90	GR	GR	GR	AL
AV-2500	5.0:1	6+1	224	66	7	0.20/230, 0.25/150, 0.30/105	GR	GR	GR	AL
AV-3000	5.0:1	6+1	220	66	7	0.20/265, 0.25/170, 0.30/115	GR	GR	GR	AL
AV-4000	5.0:1	6+1	283	76	8	0.25/260, 0.30/180, 0.35/135	GR	GR	GR	AL
AV-6000	4.5:1	6+1	400	79	15	0.30/275, 0.35/200, 0.40/155	GR	GR	GR	AL
AV-8000	4.8:1	6+1	572	97	16	0.40/210, 0.45/165, 0.50/135	GR	GR	GR	AL
AV-10000	4.8:1	6+1	557	97	16	0.40/255, 0.45/200, 0.50/165	GR	GR	GR	AL
AV-14000	4.8:1	6+1	600	109	16	0.40/370, 0.45/290, 0.50/230	GR	GR	GR	AL
Avenger LE Edition Spinning Reels										
AV-1000-LEa	5.0:1	6+1	195	61	3	0.15/250, 0.20/140, 0.25/90	GR	GR	GR	AL
AV-3000-LE	5.0:1	6+1	220	66	7	0.20/265, 0.25/170, 0.30/115	GR	GR	GR	AL
AV-4000-LE	5.0:1	6+1	283	76	8	0.25/260, 0.30/180, 0.35/135	GR	GR	GR	AL

TOMCAT

TOMCAT REELS FEATURE:

- Corrosion-resistant graphite body
- 6 ball bearings + 1 roller bearing
- Quick-Set infinite anti-reverse system
- Machine cut brass pinion
- Precision elliptical oscillation
- Multi-disc, Japanese oiled felt drag washers
- DFD : Dual Force Drag on size 14000
- RES II : Computer balanced Rotor Equalizing System
- Design rigid handle
- TPE Ergo grip handle knob
- 2 tones aluminum spool
- Metal round line clip



TOMCAT

	Model	Gear ratio	Bearings	Weight (g)	Line retrieve(cm)	Max Drag Force(kg)	Monofilament line capacity (diameter in mm.)	Frame	Sideplates	Rotor	Spool
NEW	TMC-3000	5.0:1	6+1	236	66	7	0.20/265, 0.25/170, 0.30/115	GR	GR	GR	AL
NEW	TMC-4000	5.0:1	6+1	301	76	8	0.25/260, 0.30/180, 0.35/135	GR	GR	GR	AL
	TMC-6000	4.5:1	6+1	445	79	15	0.30/275, 0.35/200, 0.40/155	GR	GR	GR	AL
	TMC-8000	4.8:1	6+1	631	97	16	0.40/210, 0.45/165, 0.50/135	GR	GR	GR	AL
	TMC-14000	4.8:1	6+1	687	109	18 (DFD)	0.40/370, 0.45/290, 0.50/230	GR	GR	GR	AL
NEW	TMC-16000	4.8:1	6+1	668	109	16	0.40/420 0.45/335 0.50/270	GR	GR	GR	AL

SCORPIO

SCORPIO REELS FEATURE:

- Corrosion-resistant graphite body
- Exclusive metal black and purple paint
- 4 ball bearing + 1 roller bearing
- Quick Set infinite anti-reverse system
- CFR : Cyclonic Flow Rotor
- Machine cut aluminum spool
- Graphite spare spool
- Smooth spool neck surface
- Zinc handle TPE flat knob
- Precision Elliptical Gearing System
- Machined cut brass pinion gear
- Gunsmoke anodized bail
- RESii: Computer-balanced rotor system
- Even Flow line roller
- Multi-disc, Japanese oiled felt drag system



SCORPIO

	Model	Gear ratio	Bearings	Weight (g)	Line retrieve (cm)	Max Drag Force(kg)	Monofilament line capacity (diameter in mm.)	Frame	Sideplates	Rotor	Spool
NEW	SP1000S-A	5.0:1	4+1	218	61	3	PE0.4(0.104)-100m / PE0.6(0.128)-60m PE0.8(0.148)-40m	GR	GR	GR	AL
NEW	SP1000-A	5.0:1	4+1	209	61	3	0.15/255, 0.20/140, 0.25/90	GR	GR	GR	AL
NEW	SP3000S-A	5.0:1	4+1	235	66	7	PE0.6(0.128)-210m / PE0.8(0.148)-150m PE1.0(0.165)-125m	GR	GR	GR	AL
NEW	SP3000-A	5.0:1	4+1	235	66	7	0.20/310, 0.25/200, 0.30/135	GR	GR	GR	AL
NEW	SP4000-A	5.0:1	4+1	302	76	8	0.25/280, 0.30/185, 0.35/130	GR	GR	GR	AL
NEW	SP5000-A	5.0:1	4+1	288	76	8	0.30/240, 0.35/170, 0.40/125	GR	GR	GR	AL
NEW	SP6000-A	4.5:1	4+1	432	79	15	0.30/315, 0.35/220, 0.40/165	GR	GR	GR	AL



TMC-14000



SP3000-A

SAFINA PRO

SAFINA PRO REELS FEATURE:

- Corrosion-resistant graphite body
- CFR : Cyclonic Flow Rotor
- 3 ball bearings + 1 roller bearing
- Quick-Set infinite anti-reverse system
- Machine cut brass pinion
- ESII : Computer balanced Rotor Equalizing System
- Multi-disc, Japanese oiled felt drag washers
- T-shape handle knob from size 4000 and up
- Precision elliptical oscillation
- Design rigid handle
- 2 tones aluminum spool
- New graphite handle



SNP-4000



SAFINA PRO

	Model	Gear ratio	Bearings	Weight (g)	Line retrieve(cm)	Max Drag Force(kg)	Monofilament line capacity (diameter in mm.)	Frame	Sideplates	Rotor	Spool
NEW	SNP-2500	5.0:1	3+1	224	66	7	0.20/230, 0.25/150, 0.30/105	GR	GR	GR	AL
NEW	SNP-3000	5.0:1	3+1	219	66	7	0.20/265, 0.25/170, 0.30/115	GR	GR	GR	AL
NEW	SNP-4000	5.0:1	3+1	282	76	8	0.25/260, 0.30/180, 0.35/135	GR	GR	GR	AL
NEW	SNP-6000	4.5:1	3+1	410	79	15	0.30/275, 0.35/200, 0.40/155	GR	GR	GR	AL
NEW	SNP-8000	4.8:1	3+1	570	97	16	0.40/210, 0.45/165, 0.50/135	GR	GR	GR	AL
NEW	SNP-14000	4.8:1	3+1	599	109	16	0.40/370, 0.45/290, 0.50/230	GR	GR	GR	AL

SAFINA

SAFINA REELS FEATURE:

- Corrosion-resistant graphite body
- CFR : Cyclonic Flow Rotor
- 1 ball bearings + 1 roller bearing
- Quick-Set infinite anti-reverse system
- Machine cut brass pinion
- Precision elliptical oscillation
- ESII : Computer balanced Rotor Equalizing System
- Multi-disc, Japanese oiled felt drag washers
- T-shape handle knob from size 8000 and up
- 2 tones aluminum spool
- New graphite handle
- Design rigid handle



SN-3000



SAFINA

	Model	Gear ratio	Bearings	Weight (g)	Line retrieve (cm)	Max Drag Force(kg)	Monofilament line capacity (diameter in mm.)	Frame	Sideplates	Rotor	Spool
NEW	SN-2500	5.0:1	1+1	221	66	7	0.20/230, 0.25/150, 0.30/105	GR	GR	GR	AL
NEW	SN-3000	5.0:1	1+1	217	66	7	0.20/265, 0.25/170, 0.30/115	GR	GR	GR	AL
NEW	SN-4000	5.0:1	1+1	281	76	8	0.25/260, 0.30/180, 0.35/135	GR	GR	GR	AL
NEW	SN-6000	4.5:1	1+1	398	79	15	0.30/275, 0.35/200, 0.40/155	GR	GR	GR	AL
NEW	SN-8000	4.8:1	1+1	570	97	16	0.40/210, 0.45/165, 0.50/135	GR	GR	GR	AL
NEW	SN-14000	4.8:1	1+1	598	109	16	0.40/370, 0.45/290, 0.50/230	GR	GR	GR	AL

SOLARIS

SOLARIS REELS FEATURE:

- Corrosion-resistant graphite body
- 5 ball bearing + 1 roller bearing
- Quick Set infinite anti-reverse system
- Aluminum black spool with blue anodizing
- Zink handle
- EVA knob 3000, Flat TPE knob C4000, TPE T-shape 5000/6000
- Machined cut brass pinion gear
- RESII: Computer-balanced rotor system
- Even Flow line roller



SLS-3000



SOLARIS

	Model	Gear ratio	Bearings	Weight (g)	Line retrieve(cm)	Max Drag Force (kg)	Monofilament line capacity (diameter in mm.)	Frame	Sideplates	Rotor	Spool
NEW	SLS-3000	5.0:1	5+1	240	71	7	0.20/300, 0.25/200, 0.30/130	GR	GR	GR	AL
NEW	SLS-C4000	5.0:1	5+1	260	85	8	0.25/260, 0.30/180, 0.35/130	GR	GR	GR	AL
NEW	SLS-5000	5.0:1	5+1	295	79	9	0.30/240, 0.35/170, 0.40/125	GR	GR	GR	AL
NEW	SLS-6000	4.5:1	5+1	430	83	14	0.30/300, 0.35/220, 0.40/170	GR	GR	GR	AL

ALARIS

ALARIS REELS FEATURE:

- Multi-disc, Japanese oiled felt drag washers
- 3 ball bearing + 1 roller bearing
- Quick-Set ant-reverse bearing
- Precision machine cut brass pinion gear
- Corrosion resistant graphite body and rotor
- Rigid metal handle design for strength
- Machined aluminum, 2-tone anodized spool with LCS lip
- Corrosion-resistant stainless steel bail wire
- RESII: Computer balanced Rotor Equalizing System



ALS-30



ALARIS

	Model	Gear ratio	Bearings	Weight (g)	Line retrieve (cm)	Max Drag Force (kg)	Monofilament line capacity (diameter in mm.)	Frame	Sideplates	Rotor	Spool
Standard speed spinning reels											
	ALS-20	4.8:1	3+1	204	61	5	0.15/250, 0.20/140, 0.25/90	GR	GR	GR	AL
	ALS-30	5.0:1	3+1	237	71	7	0.20/300, 0.25/200, 0.30/130	GR	GR	GR	AL
	ALS-40	5.0:1	3+1	260	85	8	0.25/260, 0.30/180, 0.35/130	GR	GR	GR	AL
	ALS-45	5.0:1	3+1	295	79	9	0.30/240, 0.35/170, 0.40/125	GR	GR	GR	AL
	ALS-55	4.5:1	3+1	422	83	14	0.30/300, 0.35/220, 0.40/170	GR	GR	GR	AL
	ALS-65	4.5:1	3+1	427	87	14	0.40/220, 0.45/170, 0.50/140	GR	GR	GR	AL

Model: ALS-40 Wide Rotor

ALTERA

ALTERA REELS FEATURE:

- Corrosion-resistant graphite body
- 3 ball bearing + 1 roller bearing
- Quick-Set infinite anti-reverse system
- Machine cut brass pinion gear
- Machine cut 2 tone anodized aluminum spool
- RES II : Computer balanced Rotor Equalizing System
- Rigid metal handle
- TPE handle knob (T-shape on size 55 & 65)
- Multi-disc, Japanese oiled felt drag washers



ATE-40

ATE-65



ALTERA

Model	Gear ratio	Bearings	Weight (g)	Line retrieve(cm)	Max Drag Force (kg)	Monofilament line capacity (diameter in mm.)	Frame	Sideplates	Rotor	Spool
ATE-20	4.8:1	3+1	203	61	5	0.15/250, 0.20/140, 0.25/90	GR	GR	GR	AL
ATE-30	5.0:1	3+1	240	71	7	0.20/300, 0.25/200, 0.30/130	GR	GR	GR	AL
ATE-40	5.0:1	3+1	260	85	8	0.25/260, 0.30/180, 0.35/130	GR	GR	GR	AL
ATE-45	5.0:1	3+1	295	79	9	0.30/240, 0.35/170, 0.40/125	GR	GR	GR	AL
ATE-55	4.5:1	3+1	430	83	14	0.30/300, 0.35/220, 0.40/170	GR	GR	GR	AL
ATE-65	4.5:1	3+1	430	87	14	0.40/220, 0.45/170, 0.50/140	GR	GR	GR	AL

JAW

JAW REELS FEATURE:

- Multi-disc, Japanese oiled felt drag washers
- 3 ball bearing+1 roller bearing
- Precision machine cut brass pinion gear
- Corrosion resistant graphite body and rotor
- Machined aluminum, anodized spool
- Corrosion-resistant stainless steel bail wire
- RESII: Computer balanced Rotor Equalizing System



JAW-30



JAW

Model	Gear ratio	Bearings	Weight (g)	Line retrieve(cm)	Max Drag Force (kg)	Monofilament line capacity (diameter in mm.)	Frame	Sideplates	Rotor	Spool
JAW-20	4.8:1	3+1	199	61	5	0.15/250, 0.20/140, 0.25/90	GR	GR	GR	AL
JAW-30	5.0:1	3+1	233	71	7	0.20/300, 0.25/200, 0.30/130	GR	GR	GR	AL
JAW-40	5.0:1	3+1	259	85	8	0.25/260, 0.30/180, 0.35/130	GR	GR	GR	AL
JAW-45	5.0:1	3+1	290	79	9	0.30/240, 0.35/170, 0.40/125	GR	GR	GR	AL
JAW-55	4.5:1	3+1	422	83	14	0.30/300, 0.35/220, 0.40/170	GR	GR	GR	AL

C-FIGHT

C-FIGHT SPINNING REEL FEATURE:

- Corrosion-resistant graphite body and rotor
- Exclusive Okuma black and grey camo covering
- 3 ball bearing + 1 roller bearing
- Quick-Set infinite anti-reverse system
- Machine cut brass pinion gear
- Machine cut 2 tone anodized aluminum spool
- RES II : Computer balanced Rotor Equalizing System
- Rigid metal handle
- TPE T-shape handle knob
- Multi-disc, Japanese oiled felt drag washers



CF-6000



C-FIGHT

Model	Gear ratio	Bearings	Weight (g)	Line retrieve(cm)	Max Drag Force (kg)	Monofilament line capacity (diameter in mm.)	Frame	Sideplates	Rotor	Spool
CF-6000	4.5:1	3+1	460	87	14	0.30/320, 0.35/225, 0.40/170	GR	GR	GR	AL

ARIA

ARIA REELS FEATURE:

- Multi-disc, Japanese oiled felt drag washers
- 1 ball bearing drive for smoothness and durability
- Precision machine cut brass pinion gear
- Corrosion resistant graphite body and rotor
- Machined aluminum, anodized spool
- Corrosion-resistant stainless steel bail wire
- RESII: Computer balanced Rotor Equalizing System



ARIA-30a

ARIA-55a



ARIA

Model	Gear ratio	Bearings	Weight (g)	Line retrieve(cm)	Max Drag Force (kg)	Monofilament line capacity (diameter in mm.)	Frame	Sideplates	Rotor	Spool
Standard speed spinning reels										
ARIA-20a	4.8:1	1	183	61	5	0.15/250, 0.20/140, 0.25/90	GR	GR	GR	AL
ARIA-30a	5.0:1	1	220	71	7	0.20/300, 0.25/200, 0.30/130	GR	GR	GR	AL
ARIA-40a	5.0:1	1	234	85	8	0.25/260, 0.30/180, 0.35/130	GR	GR	GR	AL
ARIA-45a	5.0:1	1	266	79	9	0.30/240, 0.35/170, 0.40/125	GR	GR	GR	AL
ARIA-55a	4.5:1	1	375	83	14	0.30/300, 0.35/220, 0.40/170	GR	GR	GR	AL
ARIA-65a	4.5:1	1	380	87	14	0.40/220, 0.45/170, 0.50/140	GR	GR	GR	AL

T-shape Handle on size 55 & 65

Fuel Spin

FUEL SPIN REELS FEATURE:

- Multi-disc, Japanese oiled felt drag washers
- 1 ball bearing drive for smoothness and durability
- Precision machine cut brass pinion gear
- Corrosion resistant graphite body and rotor
- Machined aluminum, anodized spool
- CFR: Cyclonic Flow Rotor technology
- Corrosion-resistant stainless steel bail wire
- RESII: Computer balanced Rotor Equalizing System



FSP-3000



FUEL SPIN

Model	Gear ratio	Bearings	Weight (g)	Line retrieve(cm)	Max Drag Force (kg)	Monofilament line capacity (diameter in mm.)	Frame	Sideplates	Rotor	Spool
Standard speed spinning reels										
FSP-1000	4.8:1	1	199	61	5	0.15/250, 0.20/140, 0.25/90	GR	GR	GR	AL
FSP-3000	5.0:1	1	233	71	7	0.20/300, 0.25/200, 0.30/130	GR	GR	GR	AL
FSP-C4000	5.0:1	1	259	85	8	0.25/260, 0.30/180, 0.35/130	GR	GR	GR	AL
FSP-5000	5.0:1	1	266	79	9	0.30/240, 0.35/170, 0.40/125	GR	GR	GR	AL
FSP-6000	4.5:1	1	375	83	14	0.30/300, 0.35/220, 0.40/170	GR	GR	GR	AL
FSP-8000	4.5:1	1	380	87	14	0.40/220, 0.45/170, 0.50/140	GR	GR	GR	AL

AZAKI

AZAKI REELS FEATURE:

- Corrosion-resistant graphite body
- 1 ball bearing + 1 roller bearing
- Quick-Set infinite anti-reverse system
- RES II : Computer balanced Rotor Equalizing System
- Design graphite handle
- ABS handle knob (T-shape on size 55 & 65)
- Multi-disc, Japanese oiled felt drag washers
- Machine cut brass pinion
- Aluminum spool



Azaki-40



AZAKI

Model	Gear ratio	Bearings	Weight (g)	Line retrieve(cm)	Max Drag Force (kg)	Monofilament line capacity (diameter in mm.)	Frame	Sideplates	Rotor	Spool
Azaki-20	4.8:1	1+1	187	61	5	0.15/250, 0.20/140, 0.25/90	GR	GR	GR	AL
Azaki-30	5.0:1	1+1	216	71	7	0.20/300, 0.25/200, 0.30/130	GR	GR	GR	AL
Azaki-40	5.0:1	1+1	242	85	8	0.25/260, 0.30/180, 0.35/130	GR	GR	GR	AL
Azaki-45	5.0:1	1+1	274	79	9	0.30/240, 0.35/170, 0.40/125	GR	GR	GR	AL
Azaki-55	4.5:1	1+1	404	83	14	0.30/300, 0.35/220, 0.40/170	GR	GR	GR	AL
Azaki-65	4.5:1	1+1	405	87	14	0.40/220, 0.45/170, 0.50/140	GR	GR	GR	AL
Azaki with Braided Line										
Azaki-30	5.0:1	1+1	226	71	7	0.20/300, 0.25/200, 0.30/130	GR	GR	GR	AL
Azaki-40	5.0:1	1+1	257	85	8	0.25/260, 0.30/180, 0.35/130	GR	GR	GR	AL

Pink Pearl V2

PINK PEARL V2 REELS FEATURE:

- Corrosion resistant graphite body and rotor
- 1+1 ball bearing
- Quick-set anti-reverse roller bearing
- Aluminum 2 tones anodized spool
- Multi-disc, Japanese oiled felt drag washers
- RESII: Computer balanced Rotor Equalizing System
- TPE soft touch handle knob



PP2-3000



PINK PEARL V2

Model	Gear ratio	Bearings	Weight (g)	Line retrieve(cm)	Max Drag Force (kg)	Monofilament line capacity (diameter in mm.)	Frame	Sideplates	Rotor	Spool
PP2-3000	5.0:1	1+1	216	71	7	0.20/300, 0.25/200, 0.30/130	GR	GR	GR	AL

Ceymar XT Match FD

CEYMAR XT MATCH FD REELS FEATURE:

- Corrosion-resistant graphite body
- 7 ball bearing + 1 roller bearing
- Quick Set infinite anti-reverse system
- CFR : Cyclonic Flow Rotor
- Aluminum 2 tone match spool
- Aluminum regular spare spool
- Rigid metal handle, EVA knob
- Precision Elliptical Gearing System
- Hi-speed gear ratio : 6,2:1
- Machined cut brass pinion gear
- Heavy duty, solid aluminum bail wire
- RESII: Computer-balanced rotor system
- Even Flow line roller
- Multi-disc, Japanese oiled felt drag system



CXT-30MS



CEYMAR XT MATCH FD

Model	Gear ratio	Bearings	Weight (g)	Line retrieve(cm)	Max Drag Force (kg)	PE line capacity (diameter in mm.)	Frame	Sideplates	Rotor	Spool	Extra Spool
CXT-30MS	6.2:1	7+1	241	84	7	PE0.6(0.128mm)-250M PE0.8(0.148mm)-150M PE1.0(0.165mm)-130M	GR	GR	GR	AL	AL
CXT-40MS	6.2:1	7+1	301	97	8	PE1.0(0.165mm)-170M PE1.2(0.185mm)-150M PE1.5(0.205mm)-120M	GR	GR	GR	AL	AL

Carbonite V2 Match

CARBONITE V2 MATCH BF RD & FD FEATURE:

- Corrosion-resistant graphite body
- CFR : Cyclonic Flow Rotor
- 2 ball bearings + 1 roller bearing
- Quick-Set infinite anti-reverse system
- Aluminum 2 tone match spool
- Round metal line clip
- Regular graphite spare spool
- Rigid metal double handle, EVA knob
- Precision Elliptical Gearing System
- Machined cut brass pinion gear
- RESII: Computer-balanced rotor system
- Even Flow line roller
- Hi-speed gear ratio : 6,2:1



CARBONITE V2 MATCH FD & RD

Model	Gear ratio	Bearings	Weight (g)	Line retrieve(cm)	Max Drag Force (kg)	PE line capacity (diameter in mm.)	Frame	Sideplates	Rotor	Spool	Extra Spool
CBV-40MSDH	6.2:1	2+1	338	97	8	PE1.0(0.165mm)-170M PE1.2(0.185mm)-150M PE1.5(0.205mm)-120M	GR	GR	GR	AL	GR
CBV-40MRS DH	6.2:1	2+1	340	97	8	PE1.0(0.165mm)-170M PE1.2(0.185mm)-150M PE1.5(0.205mm)-120M	GR	GR	GR	AL	GR

Custom Black Feeder

CUSTOM BLACK FEEDER FEATURE:

- Corrosion-resistant graphite body
- 7 ball bearing + 1 roller bearing
- Quick Set infinite anti-reverse system
- CFR : Cyclonic Flow Rotor
- Machine cut Aluminum shallow spool
- Aluminum regular spare spool
- Rigid metal handle, EVA knob
- Precision Elliptical Gearing System
- Machined cut brass pinion gear
- Heavy duty, solid aluminum bail wire
- RESII : Computer-balanced rotor system
- Even Flow line roller
- Multi-disc, Japanese oiled felt drag system



CUSTOM BLACK FEEDER

Model	Gear ratio	Bearings	Weight (g)	Line retrieve(cm)	Max Drag Force (kg)	Monofilament line capacity (diameter in mm.)	Frame	Sideplates	Rotor	Spool	Extra Spool
CLX-40F	5.0:1	7+1	291	76	8	0.25/180, 0.28/140, 0.30/125	GR	GR	GR	AL	AL
CLX-55F	4.5:1	7+1	437	79	15	0.30/180, 0.33/150, 0.35/130	GR	GR	GR	AL	AL

Carbonite XP Feeder

CARBONITE XP FEEDER FEATURE:

- Corrosion-resistant graphite body
- CFR : Cyclonic Flow Rotor
- 2 ball bearings + 1 roller bearing
- Quick-Set infinite anti-reverse system
- Aluminum 2 tone shallow spool
- Round metal line clip
- Rigid metal handle, EVA knob
- Precision Elliptical Gearing System
- Machined cut brass pinion gear
- RESII: Computer-balanced rotor system
- Even Flow line roller



CARBONITE XP FEEDER

Model	Gear ratio	Bearings	Weight (g)	Line retrieve(cm)	Max Drag Force (kg)	Monofilament line capacity (diameter in mm.)	Frame	Sideplates	Rotor	Spool
CBV-40F	5.0:1	2+1	291	76	8	0.25/180, 0.28/140, 0.30/125	GR	GR	GR	AL
CBV-55F	4.5:1	2+1	442	79	15	0.30/180, 0.33/150, 0.35/130	GR	GR	GR	AL



Carbonite Match

CARBONITE RD FEATURE:

- Corrosion resistant graphite body and rotor
- 1+1 ball bearing
- Quick-set anti-reverse roller bearing
- Match graphite spool
- Regular extra graphite spool
- CFR: Cyclonic Flow Rotor technology
- RESII: Computer balanced Rotor Equalizing System
- EVA handle knob



CARBONITE MATCH

Model	Gear ratio	Bearings	Weight (g)	Line retrieve(cm)	Max Drag Force (kg)	Monofilament line capacity (diameter in mm.)	Frame	Sideplates	Rotor	Spool	Extra Spool
CRM-4000S	5.0:1	1+1	264	76	6	PE 0.6 (0.128MM) - 250M PE 0.8 (0.148MM) - 150M PE 1.0 (0.165MM) - 130M	GR	GR	GR	GR	GR



CARBONITE

CARBONITE RD FEATURE:

- Corrosion resistant graphite body and rotor
- 1+1 ball bearing
- Quick-set anti-reverse roller bearing
- Graphite spool
- CFR: Cyclonic Flow Rotor technology
- RESII: Computer balanced Rotor Equalizing System
- TPE handle knob



CR-2500



CARBONITE

Model	Gear ratio	Bearings	Weight (g)	Line retrieve(cm)	Max Drag Force (kg)	Monofilament line capacity (diameter in mm.)	Frame	Sideplates	Rotor	Spool
CR-2500	5.0:1	1+1	218	66	4	0.20/255, 0.25/170, 0.30/110	GR	GR	GR	GR
CR-4000	5.0:1	1+1	268	76	6	0.25/250, 0.30/170, 0.35/130	GR	GR	GR	GR

REVENGER

REVENGER REELS FEATURE:

- Multi-disc, oiled felt drag system
- 1 ball bearing for ultimate smoothness
- Multi-stop anti-reverse system
- Graphite spool
- Corrosion-resistant graphite body
- Corrosion-resistant, stainless steel bail wire
- RESII: Computer balanced Rotor Equalizing System



REVENGER

Model	Gear ratio	Bearings	Weight (g)	Line retrieve(cm)	Max Drag Force (kg)	Monofilament line capacity (diameter in mm.)	Frame	Sideplates	Rotor	Spool
RV-25	5.0:1	1	215	64.5	3	0.15/320, 0.20/190, 0.25/120	GR	GR	GR	GR
RV-30	5.0:1	1	215	64.5	5	0.20/220, 0.25/140, 0.30/100	GR	GR	GR	GR
RV-40	5.0:1	1	250	76.2	5	0.25/270, 0.30/190, 0.35/140	GR	GR	GR	GR
RV-55	4.5:1	1	365	76.2	9	0.30/390, 0.35/285, 0.40/220	GR	GR	GR	GR
RV-65	4.8:1	1	560	94.0	11	0.35/360, 0.40/280, 0.50/170	GR	GR	GR	GR
RV-80	4.8:1	1	586	104.1	12	0.45/280, 0.50/225, 0.55/190	GR	GR	GR	GR



RV-25

REVENGER PRO

REVENGER PRO REELS FEATURE:

- Multi-disc, oiled felt drag system
- 1 ball bearing for ultimate smoothness
- Multi-stop anti-reverse system
- Machined aluminum, anodized spool
- Corrosion-resistant graphite body
- Rigid aluminum handle arm for strength
- Corrosion-resistant, stainless steel bail wire
- RESII: Computer balanced Rotor Equalizing System



RVP-30



REVENGER PRO

Model	Gear ratio	Bearings	Weight (g)	Line retrieve (cm)	Max Drag Force (kg)	Monofilament line capacity (diameter in mm.)	Frame	Sideplates	Rotor	Spool
RVP-25	5.0:1	1	220	64.5	3	0.15/320, 0.20/190, 0.25/120	GR	GR	GR	AL
RVP-30	5.0:1	1	220	64.5	5	0.20/220, 0.25/140, 0.30/100	GR	GR	GR	AL
RVP-40	5.0:1	1	260	76.2	5	0.25/270, 0.30/190, 0.35/140	GR	GR	GR	AL
RVP-55	4.5:1	1	365	76.2	9	0.30/390, 0.35/285, 0.40/220	GR	GR	GR	AL
RVP-65	4.8:1	1	560	94.0	11	0.35/360, 0.40/280, 0.50/170	GR	GR	GR	AL
RVP-80	4.8:1	1	586	104.1	12	0.45/280, 0.50/225, 0.55/190	GR	GR	GR	AL

CASCADE

CASCADE REELS FEATURES:

- Multi-disc, oiled felt drag system
- 1 ball bearing for ultimate smoothness
- Multi-stop anti-reverse system
- Silver electroplated ABS spool
- Corrosion-resistant graphite body
- Corrosion-resistant, stainless steel bail wire
- RESII: Computer balanced Rotor Equalizing System



CASCADE

Model	Gear ratio	Bearings	Weight (g)	Line retrieve (cm)	Max Drag Force (kg)	Monofilament line capacity (diameter in mm.)	Frame	Sideplates	Rotor	Spool
CA-25	5.0:1	1	215	64.5	3	0.15/320, 0.20/190, 0.25/120	GR	GR	GR	GR
CA-30	5.0:1	1	215	64.5	5	0.20/220, 0.25/140, 0.30/100	GR	GR	GR	GR
CA-40	5.0:1	1	250	76.2	5	0.25/270, 0.30/190, 0.35/140	GR	GR	GR	GR
CA-55	4.5:1	1	365	76.2	9	0.30/390, 0.35/285, 0.40/220	GR	GR	GR	GR
CA-65	4.8:1	1	560	94.0	11	0.35/360, 0.40/280, 0.50/170	GR	GR	GR	GR
CA-80	4.8:1	1	586	104.1	12	0.45/280, 0.50/225, 0.55/190	GR	GR	GR	GR



CA-25

Aventa

AVENTA BAITFEEDER REELS FEATURE:

- On/Off auto trip bait feeding system
- Spare aluminum spool
- 6+1RB bearing drive system for smoothness
- Metal line clip
- Quick set anti-reverse roller bearing
- LCS Line control spool
- Precision machine cut brass pinion gear
- Corrosion resistant graphite body
- Slow oscillation precision gearing system
- Machined aluminum spool
- One touch handle with wood knob



AVENTA BF

Model	Gear ratio	Bearings	Weight (g)	Line retrieve (cm)	Max Drag Force (kg)	Monofilament line capacity (diameter in mm.)	Frame	Sideplates	Rotor	Spool	Extra Spool
AB-5000	4.8:1	6+1	527	68.6	12	0.35/235, 0.40/180, 0.50/110	GR	GR	GR	AL	AL
AB-6000	4.8:1	6+1	533	71.1	12	0.35/280, 0.40/215, 0.50/135	GR	GR	GR	AL	AL
AB-8000	4.8:1	6+1	763	78.7	15	0.35/405, 0.40/311, 0.50/190	GR	GR	GR	AL	AL
AB-10000	4.8:1	6+1	778	86.4	15	0.45/310, 0.50/250, 0.55/210	GR	GR	GR	AL	AL

Coronado CDX

CORONADO CDX BAITFEEDER REELS FEATURE:

- On/Off auto trip bait feeding system
- DFD: Precision Dual Force Drag system
- Carbonite drag washers on Dual Force Drag
- Heavy duty, brass DFD and spool shaft stabilizer
- 4HPB+1RB corrosion resistant stainless steel bearings
- Quick-Set ant-reverse bearing allows for zero back play in handle
- CRC: Corrosion-Resistant Coasting process
- Machined aluminum, screw in handle system
- Slow oscillation system for improved line lay



CORONADO CDX

Model	Gear ratio	Bearings	Weight (g)	Line retrieve (cm)	Max Drag Force (kg)	Monofilament line capacity (diameter in mm.)	Braided line rating (Tuf line)	Frame	Sideplates	Rotor	Spool
Standard speed spinning reels											
CDX-55	4.4 : 1	4+1	550	82.6	12.7	0.30/320,0.35/230,0.40/180	245/50	GR	GR	GR	AL
CDX-60	4.4 : 1	4+1	563	86.7	12.2	0.30/375,0.35/275,0.40/210	290/50	GR	GR	GR	AL
CDX-65	4.9 : 1	4+1	822	106.0	15.3	0.40/300,0.45/235,0.50/190	315/65	GR	GR	GR	AL
CDX-80	4.9 : 1	4+1	855	115.3	17	0.40/380,0.45/300,0.50/240	235/80	GR	GR	GR	AL



AB-5000

AVENGER ABF

AVENGER ABF REELS FEATURE:

- On/Off auto trip bait feeding system
- Multi-disc, Japanese oiled felt drag system
- 6BB + 1RB stainless steel bearing system
- Corrosion resistant frame, sideplate and rotor
- Rigid metal handle design to reduce flex
- RESII: Computer balanced Rotor Equalizing System
- Machined aluminum, 2-tone anodized spool
- Quick-Set anti-reverse roller bearing
- CFR: Cyclonic Flow Rotor technology
- Precision machine cut brass pinion gear



AVENGER BF

Model	Gear ratio	Bearings	Weight (g)	Line retrieve (cm)	Max Drag Force (kg)	Monofilament line capacity (diameter in mm.)	Frame	Sideplates	Rotor	Spool
ABF-500	5.0:1	6+1	218	56	3	0.15/145, 0.20/80, 0.25/50	GR	GR	GR	AL
ABF-1000	5.0:1	6+1	234	61	3	0.15/250, 0.20/140, 0.25/90	GR	GR	GR	AL
NEW ABF-3000	5.0:1	6+1	285	71	8	0.20/310, 0.25/200, 0.30/135	GR	GR	GR	AL
ABF-4000	5.0:1	6+1	331	79	10	0.25/285, 0.3/190, 0.35/130	GR	GR	GR	AL
ABF-6000	4.5:1	6+1	483	80	12	0.30/320, 0.35/225, 0.40/170	GR	GR	GR	AL
ABF-8000	4.5:1	6+1	503	87	12	0.40/230, 0.45/180, 0.50/140	GR	GR	GR	AL



ABF-1000

TOMCAT

TOMCAT BAITFEEDER REELS FEATURE:

- Auto-switch freespool system
- Rigid metal handle
- Largest line capacity Okuma freespool reel
- TPE ergo grip handle knob
- Designed for Catfish fishing
- Machine cut brass pinion
- Corrosion-resistant graphite body
- 5 ball bearings + 1 roller bearing
- Quick-Set infinite anti-reverse system
- S-curve oscillation system
- 2 tones machine cut aluminum spool
- Gunsmoke anodized bail
- Multi-disc, Japanese oiled felt drag washers



TOMCAT BAITFEEDER

Model	Gear ratio	Bearings	Weight (g)	Line retrieve (cm)	Max Drag Force (kg)	Monofilament line capacity (diameter in mm.)	Frame	Sideplates	Rotor	Spool
NEW TCBF-18000	4.5:1	5+1	820	106	10	0.50/320, 0.55/260, 0.60/215	GR	GR	GR	AL



TCBF-18000

LongBow XT

LongBow XT BAITFEEDER REELS FEATURE:

- On/Off auto trip bait feeding system
- Multi-disc, oiled felt drag system
- 5+1BB bearing drive system for smoothness
- Multi-stop anti-reverse system
- Corrosion-resistant graphite body
- Precision Elliptical Gearing system
- Machined aluminum anodized spool
- RESII: Computer balanced Rotor Equalizing System
- Metal line clip
- Spare graphite spool
- LCS line control spool

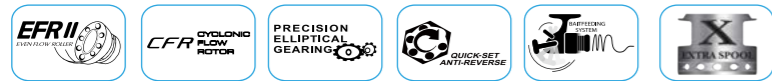

LongBow XT BF

Model	Gear ratio	Bearings	Weight (g)	Line retrieve (cm)	Max Drag Force (kg)	Monofilament line capacity (diameter in mm.)	Frame	Sideplates	Rotor	Spool	Extra Spool
LBXT-630	5.0:1	5+1	232	63.5	3	0.20/240, 0.25/155, 0.30/110	GR	GR	GR	AL	GR
LBXT-640	5.0:1	5+1	283	73.7	6	0.25/300, 0.30/210, 0.35/155	GR	GR	GR	AL	GR
LBXT-655	4.5:1	5+1	406	76.2	9	0.30/380, 0.35/280, 0.40/215	GR	GR	GR	AL	GR
LBXT-665	4.8:1	5+1	586	91.4	11	0.35/390, 0.40/300, 0.50/185	GR	GR	GR	AL	GR



LBXT-630

Ceymar

Ceymar BAITFEEDER REELS FEATURE:

- Baitfeeder quick release Aluminum spool
- Multi-disc, oiled felt drag system
- RESII: Computer balanced Rotor Equalizing System
- 2+1BB bearing drive system
- Quick-Set anti-reverse roller bearing
- Precision machine cut brass pinion gear
- Corrosion-resistant graphite body
- Light weight, ABS handle knobs
- Precision Elliptical Gearing system
- Machined aluminum, anodized spool
- Metal line clip
- LCS line control spool
- Extra graphite spool



Ceymar BF

Model	Gear ratio	Bearings	Weight (g)	Line retrieve (cm)	Max Drag Force (kg)	Monofilament line capacity (diameter in mm.)	Frame	Sideplates	Rotor	Spool	Extra Spool
CMBF-330	5.0:1	2+1	232	63.5	3	0.20/240, 0.25/155, 0.30/110	GR	GR	GR	AL	GR
CMBF-340	5.0:1	2+1	283	73.7	6	0.25/300, 0.30/210, 0.35/155	GR	GR	GR	AL	GR
CMBF-355	4.5:1	2+1	403	76.2	9	0.30/380, 0.35/280, 0.40/215	GR	GR	GR	AL	GR
CMBF-365	4.8:1	2+1	586	91.4	11	0.35/390, 0.40/300, 0.50/185	GR	GR	GR	AL	GR



CMBF-355

Ceymar

Ceymar BAITFEEDER REELS FEATURE:

- On/Off auto trip bait feeding system
- Multi-disc, Japanese oiled felt drag washers
- 7BB+1RB stainless steel bearings
- Quick-Set ant-reverse bearing
- Precision machine cut brass pinion gear
- Corrosion resistant graphite body and rotor
- Rigid metal handle design for strength
- Machined aluminum, 2-tone anodized spool with LCS lip
- Heavy duty solid aluminum bail wire
- RESII: Computer balanced Rotor Equalizing System



Ceymar BF

Model	Gear ratio	Bearings	Weight (g)	Line retrieve (cm)	Max Drag Force (kg)	Monofilament line capacity (diameter in mm.)	Frame	Sideplates	Rotor	Spool
NEW CBF-500	5.0:1	7+1	209	56	3	0.15/145, 0.20/80, 0.25/50	GR	GR	GR	AL
NEW CBF-1000	5.0:1	7+1	225	61	3	0.15/250, 0.2/140, 0.25/90	GR	GR	GR	AL
NEW CBF-3000	5.0:1	7+1	270	71	8	0.20/310, 0.25/200, 0.30/135	GR	GR	GR	AL



CBF-3000

Pulzar

Pulzar BAITFEEDER REELS FEATURE:

- Auto-switch freespool system
- Corrosion-resistant graphite body
- 5 ball bearing + 1 roller bearing
- Quick Set infinite anti-reverse system
- Machine cut aluminum spool
- Round metal line clip
- Graphite spare spool
- Easy folding aluminum handle
- Wooden handle knob
- S-curve oscillation system
- Machined cut brass pinion gear
- Heavy duty, solid aluminum bail wire
- RESII: Computer-balanced rotor system
- Even Flow line roller



Pulzar BF

Model	Gear ratio	Bearings	Weight (g)	Line retrieve (cm)	Max Drag Force (kg)	Monofilament line capacity (diameter in mm.)	Frame	Sideplates	Rotor	Spool	Extra Spool
PZB-4000	5.0:1	5+1	333	79	10	0.25/260, 0.30/180, 0.35/130	GR	GR	GR	AL	GR
PZB-6000	4.5:1	5+1	493	80	12	0.30/300, 0.35/220, 0.40/170	GR	GR	GR	AL	GR
PZB-7000	4.5:1	5+1	523	87	12	0.40/195, 0.45/150, 0.50/125	GR	GR	GR	AL	GR



PZB-6000

DYNA DRAG XP

DYNA DRAG XP BAITFEEDER REELS FEATURE:

- Auto-switch freespool system
- Corrosion-resistant graphite body
- 3 ball bearing + 1 roller bearing
- Quick Set infinite anti-reverse system
- Machine cut aluminum spool
- S-curve oscillation system
- Machined cut brass pinion gear
- RESII: Computer-balanced rotor system
- Graphite spare spool from size 4000 and up
- Even Flow line roller
- Round metal line clip
- Rigid metal handle
- T-shape TPE knob



DAXP-4000



DYNA DRAG XP FB

Model	Gear ratio	Bearings	Weight (g)	Line retrieve (cm)	Max Drag Force (kg)	Monofilament line capacity (diameter in mm.)	Frame	Sideplates	Rotor	Spool
DAXP-1000	5.0:1	3+1	228	61	3	0.15/250, 0.20/140, 0.25/90	GR	GR	GR	AL
NEW DAXP-3000	5.0:1	3+1	280	71	8	0.20/310, 0.25/200, 0.30/135	GR	GR	GR	AL
DAXP-4000	5.0:1	3+1	331	79	10	0.25/260, 0.30/180, 0.35/130	GR	GR	GR	AL
DAXP-6000	4.5:1	3+1	482	80	12	0.30/300, 0.35/220, 0.40/170	GR	GR	GR	AL
DAXP-7000	4.5:1	3+1	509	87	12	0.40/195, 0.45/150, 0.50/125	GR	GR	GR	AL

POWERLINER PRO

POWERLINER PRO BAITFEEDER REELS FEATURE:

- On/Off auto trip bait feeding system
- Multi-disc, oiled felt drag system
- 4+1BB bearing drive system for smoothness
- Multi-stop anti-reverse system
- Corrosion-resistant graphite body
- Precision Elliptical Gearing system
- Machined aluminum, anodized spool
- Durable stainless steel bail wire
- RESII: Computer balanced Rotor Equalizing System
- Metal line clip
- Spare graphite spool



PLP-6000



POWERLINER PRO

Model	Gear ratio	Bearings	Weight (g)	Line retrieve (cm)	Max Drag Force (kg)	Monofilament line capacity (diameter in mm.)	Frame	Sideplates	Rotor	Spool	Extra Spool
NEW PLP-6000	4.5:1	4+1	669	102	15	0.30/390, 0.33/315, 0.35/280	GR	GR	GR	AL	GR
NEW PLP-8000	4.5:1	4+1	683	102	16	0.33/440, 0.35/385, 0.38/320	GR	GR	GR	AL	GR

Lotus Baitfeeder

LOTUS BAITFEEDER REELS FEATURE:

- Auto-switch freespool system
- Corrosion-resistant graphite body
- 3 ball bearing + 1 roller bearing
- Quick-Set anti-reverse roller bearing
- Machine cut aluminum spool
- Round metal line clip
- Graphite spare spool
- Rigid metal handle
- T-shape TPE handle knob
- S-curve oscillation system
- Machined cut brass pinion gear
- RESII: Computer-balanced rotor system
- Even Flow line roller



LTB-6000



LOTUS BAITFEEDER

Model	Gear ratio	Bearings	Weight (g)	Line retrieve (cm)	Max Drag Force (kg)	Monofilament line capacity (diameter in mm.)	Frame	Sideplates	Rotor	Spool	Extra Spool
LTB-6000	4.5:1	3+1	480	80	12	0.30/300, 0.35/220, 0.40/170	GR	GR	GR	AL	GR

AK

AK BAITFEEDER REELS FEATURE:

- Auto-switch freespool system
- Corrosion-resistant graphite body
- 1 ball bearing + 1 roller bearing
- Quick Set infinite anti-reverse system
- Aluminum spool
- Design graphite handle
- ABS knob
- S-curve oscillation system
- Machined cut brass pinion gear
- RESII: Computer-balanced rotor system
- Even Flow line roller
- Graphite spare spool



AK-4000



AK BF

Model	Gear ratio	Bearings	Weight (g)	Line retrieve (cm)	Max Drag Force (kg)	Monofilament line capacity (diameter in mm.)	Frame	Sideplates	Rotor	Spool	Extra Spool
AK-4000	5.0:1	1+1	304	79	10	0.25/260, 0.30/180, 0.35/130	GR	GR	GR	AL	GR
AK-5000	4.5:1	1+1	458	80	12	0.30/230, 0.35/170, 0.40/130	GR	GR	GR	AL	GR
With mono Line											
AK-6000	4.5:1	1+1	445	80	12	0.30/300, 0.35/220, 0.40/170	GR	GR	GR	AL	GR

Carbonite B-Feeder

CARBONITE B-FEEDER REELS FEATURE:

- Auto-switch freespool system
- Corrosion-resistant graphite body
- 1 ball bearing + 1 roller bearing
- Quick Set infinite anti-reverse system
- Multi-disc, oiled felt drag system
- Graphite painted spool
- Graphite spare spool
- S-curve oscillation system
- Machined cut brass pinion gear
- RESII: Computer-balanced rotor system
- Even Flow line roller



CARBONITE B-FEEDER

	Model	Gear ratio	Bearings	Weight (g)	Line retrieve (cm)	Max Drag Force (kg)	Monofilament line capacity (diameter in mm.)	Frame	Sideplates	Rotor	Spool	Extra Spool
NEW	CBBF-4000	5.0:1	1+1	285	79	8	0.25/250, 0.30/165, 0.35/115	GR	GR	GR	GR	GR
NEW	CBBF-5000	4.5:1	1+1	396	79	12	0.30/275, 0.35/195, 0.40/145	GR	GR	GR	GR	GR



CBBF-4000

CARBONITE XP

CARBONITE XP BAITFEEDER REELS FEATURE:

- Baitfeeder quick release graphite spool
- Graphite spool
- With green line
- 1 BB bearing drive system
- Precision Elliptical Gearing System
- Plastic line clip
- Spare graphite spool
- Machined cut brass pinion gear
- RESII: Computer balanced Rotor System
- Even flow roller



CARBONITE XP

	Model	Gear ratio	Bearings	Weight (g)	Line retrieve (cm)	Max Drag Force (kg)	Monofilament line capacity (diameter in mm.)	Frame	Sideplates	Rotor	Spool	Extra Spool
	CBF-140a	5.0:1	1	280	71.6	6	0.30/170, 0.35/130, 0.40/100	GR	GR	GR	GR	GR
	CBF-155a	4.5:1	1	400	75.7	9	0.35/260, 0.40/200, 0.50/120	GR	GR	GR	GR	GR



CBF-155a

ATOMIC CARP

ATOMIC CARP REELS FEATURE:

- Corrosion resistant graphite body and rotor
- Multi-stop anti-reverse system
- Aluminum anodized spool
- Multi-disc, Japanese oiled felt drag washers
- RESII: Computer balanced Rotor Equalizing System
- EFR II : Even Flow Line Roller
- ABS T-shape handle knob



ATOMIC CARP

	Model	Gear ratio	Bearings	Weight (g)	Line retrieve (cm)	Max Drag Force (kg)	Monofilament line capacity (diameter in mm.)	Frame	Sideplates	Rotor	Spool
	ATC-7000	4.5:1	3	590	103	15	0.33/370, 0.35/325, 0.38/270	GR	GR	GR	AL



ATC-7000

CUSTOM

CUSTOM REELS FEATURE:

- Corrosion resistant graphite body and rotor
- 3 ball bearings + 1 roller bearing
- Quick-Set infinite anti-reverse system
- Aluminum anodized spool
- Graphite spare spool
- CFR : Cyclonic Flow Rotor
- 2 round metal line clips
- Multi-disc, Japanese oiled felt drag washers
- RESII: Computer balanced Rotor Equalizing System
- EFR II : Even Flow Line Roller
- Soft touch ABS T-shape handle knob
- Spod version CS : Prespooled with 200m Braid 30 lbs



CUSTOM

	Model	Gear ratio	Bearings	Weight (g)	Line retrieve (cm)	Max Drag Force (kg)	Monofilament line capacity (diameter in mm.)	Frame	Sideplates	Rotor	Spool	Extra Spool
NEW	C-7000	4.8:1	3+1	622	107	16	0.33/370, 0.35/325, 0.38/270	GR	GR	GR	AL	GR



C-7000

CUSTOM SPOD

	Model	Gear ratio	Bearings	Weight (g)	Line retrieve (cm)	Max Drag Force (kg)	Monofilament line capacity (diameter in mm.)	Frame	Sideplates	Rotor	Spool
NEW	CS-7000S	4.8:1	3+1	665	107	16	0.20/410, 0.22/340, 0.25/270	GR	GR	GR	AL

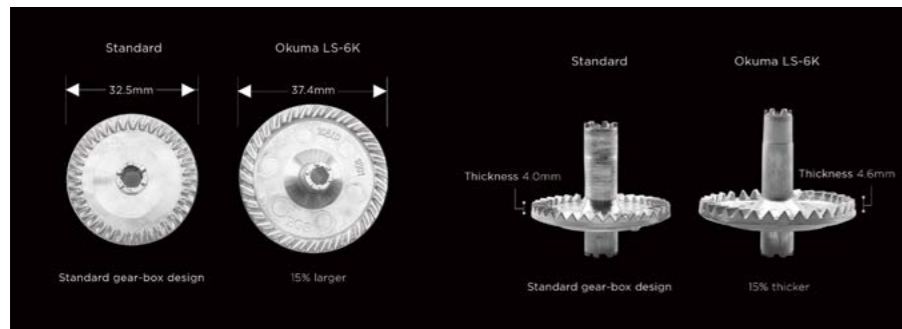

OVERSIZE GEAR

Okuma has redesigned the main transmission gear. Larger diameter + 15% and deeper teeth+15% for maximum power retrieve+30% Allows now high speed gear ratio for big line retrieve: 103cm

DOUBLE BALL BEARINGS PINION SUPPORT

Ultimate pinion stability for perfect main gear adjustment : super smooth gearing feeling and high durability.

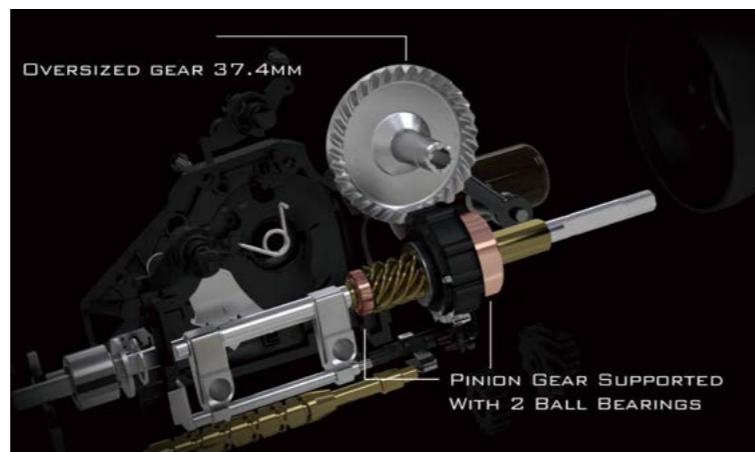

LS

LS REELS FEATURE:

- Auto-switch freespool system
- Long Stroke spool trip 30mm
- Corrosion-resistant graphite body
- 5 ball bearing + 1 roller bearing
- Quick Set infinite anti-reverse system
- Machine cut aluminum spool
- Worm shaft oscillation system
- Machined cut brass pinion gear
- Heavy duty, solid aluminum bail wire
- Precision zinc handle arm with wooden handle knob
- RESII: Computer-balanced rotor system
- Slow oscillation system for improved line lay
- 2 round metal line clips
- Rotor brake system
- Fast progressive drag
- Metal air bail nut



LS-6K



Model	Gear ratio	Bearings	Weight (g)	Line retrieve (cm)	Max Drag Force (kg)	Monofilament line capacity (diameter in mm.)	Frame	Sideplates	Rotor	Spool
LS-6K	5.3:1	5+1	530	104	12	0.30/370, 0.33/300, 0.35/270	GR	GR	GR	AL
NEW LS-8K	5.3:1	5+1	588	123	16	0.33/440, 0.35/385, 0.38/320	GR	GR	GR	AL



FOR THOSE WHO APPRECIATE THE NATURE OF CARP

Carp's intelligent and sensitive behavior makes for an incomparable fishing experience. These fish require anglers to truly understand and admire their catch. At Okuma, we aim to help carp anglers enjoy this unique connection to nature.





8K

8K REELS FEATURE:

- Quick set anti reverse roller bearing
- Slow oscillation system
- 5 ball bearing+1 roller bearing
- Fast drag system
- Double stainless steel line clickers
- Precision worm shaft transmission system
- Rotor brake system
- Hydro block water tight drag seal
- With carbon washers
- Precision zinc handle arm with wooden knob



8K



Model	Gear ratio	Bearings	Weight (g)	Line retrieve(cm)	Max Drag Force (kg)	Monofilament line capacity (diameter in mm.)	Frame	Sideplates	Rotor	Spool
8K	4.7:1	5+1	743	108	18	0.33/620, 0.35/550, 0.38/470	GR	GR	GR	AL

SLOW OSCILLATION SYSTEM

Makes the line wind more straight and tight, reduce the friction when casting. Uper Long Stroke Spool 45mm.



SUPER LONG STROKE SPOOL 45MM



FAST PROGRESSIVE DRAG

This fast progressive drag allows a setting from low drag power to almost full drag power in less than 360° rotation



SPARE ALUMINUM SHALLOW SPOOL (ON OPTION)



ROTOR WITH BRUSH GUARDS

Prevent line twist between rotor and main shaft effectively.



WORM SHAFT TRANSMISSION SYSTEM

8K equips upgraded worm shaft transmission system, strengthens the construction, let the reel more rigid, makes the line wind more straight and tight, working more smoothly.

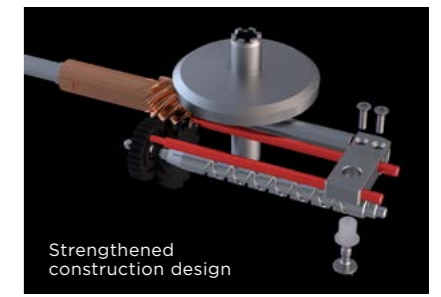

ROTOR BRAKE SYSTEM

Prevent rotor to turn around and reverse when casting.

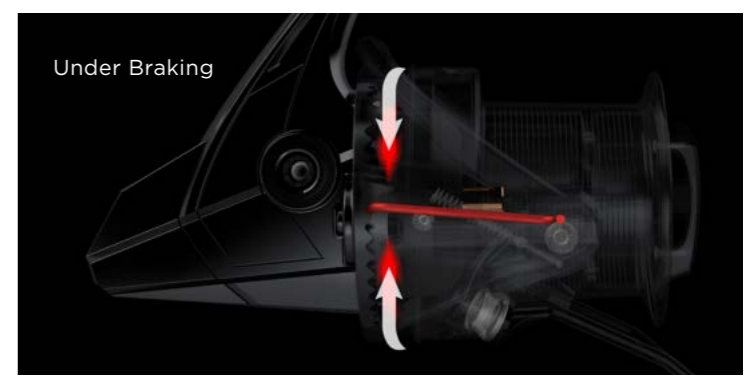

SURF-8K

SURF 8K REELS FEATURE:

- Quick set anti reverse roller bearing
- Slow oscillation system
- Fast drag system
- Double stainless steel line clickers
- Precision worm shaft transmission system
- Rotor brake system
- Hydro block water tight drag seal
- With carbon washers
- Precision zinc handle arm with TPE ergo grip



SURF-8K



SURF 8K

Model	Gear ratio	Bearings	Weight (g)	Line retrieve (cm)	Max Drag Force (kg)	Monofilament line capacity (diameter in mm.)	Frame	Sideplates	Rotor	Spool
SURF-8K	4.7:1	5+1	763	108	18	0.33/620, 0.35/550, 0.38/470	GR	GR	GR	AL

DISTANCE SURF ARENA

DISTANCE SURF ARENA REELS FEATURE:

- Slim Blade corrosion-resistant graphite body
- 3 ball bearing + 1 roller bearing
- Quick Set infinite anti-reverse system
- Machine cut aluminum spool
- LCS : round metal line clip
- FPD : Fast Progressive Drag
- Rigid metal handle
- TPE T-Shape handle knob
- Worm Shaft transmission system
- Even Flow line roller
- Hydro block drag system



DSA-60



DISTANCE SURF ARENA

Model	Gear ratio	Bearings	Weight (g)	Line retrieve(cm)	Max Drag Force (kg)	Monofilament line capacity (diameter in mm.)	Frame	Sideplates	Rotor	Spool
DSA-60	4.5:1	3+1	578	103	16	0.33/320, 0.35/280, 0.38/240	GR	GR	GR	AL
DSA-80	3.8:1	3+1	673	92	16	0.33/390, 0.35/345, 0.38/295	GR	GR	GR	AL

ROCKAWAY

ROCKAWAY REELS FEATURES:

- 4BB + 1RB stainless steel bearing system
- Quick-Set anti-reverse roller bearing
- 5.3:1 gear ratio with 104cm of line pickup
- Precision machine cut brass pinion gear
- Corrosion resistant frame, sideplate and rotor
- Rigid metal handle design to reduce flex
- Long cast, 2-tone anodized aluminum spool



ROCKAWAY

Model	Gear ratio	Bearings	Weight (g)	Line retrieve(cm)	Max Drag Force (kg)	Monofilament line capacity (diameter in mm.)	Frame	Sideplates	Rotor	Spool
RA-6000	5.3:1	4+1	486	104	12	0.30/370, 0.33/300, 0.35/270	GR	GR	GR	AL



RA-6000

T-REX

T-REX SPINNING REELS FEATURE:

- SRS : Solid Reel System
- Crossover Construction design
- Quick-Set anti-reverse roller bearing
- Worm shaft transmission system
- Precision machine cut brass pinion gear
- LCS : Line Control Spool for longer casting distance
- Fast Progressive Drag System
- Multi disc, Japanese oiled felt drag system
- Forged aluminum handle with wooden knob
- Hydro Block water tight drag seal
- Heavy duty, solid aluminum, anodized bail wire
- RESII: Computer balanced Rotor Equalizing System
- Aluminum spool
- Round metal line clip



T-REX

Model	Gear ratio	Bearings	Weight (g)	Line retrieve (cm)	Max Drag Force (kg)	Monofilament line capacity (diameter in mm.)	Frame	Sideplates	Rotor	Spool
TR-7000	4.5:1	6+1	616	102	12	0.33/370, 0.35/325, 0.38/270	AL/GR	GR	AL/GR	AL



TR-7000

CUSTOM BLACK

CUSTOM BLACK REELS FEATURE:

- 3 +1 stainless steel bearings
- Quick-Set anti-reverse roller bearing
- Machine cut anodizing alum spool
- Aluminum regular handle
- Hydro block system
- Even flow roller
- Worm shaft transmission system
- LCS line control spool
- Metal line clip
- Spare graphite spool



CUSTOM BLACK

Model	Gear ratio	Bearings	Weight (g)	Line retrieve (cm)	Max Drag Force (kg)	Monofilament line capacity (diameter in mm.)	Frame	Sideplates	Rotor	Spool	Extra Spool
CB-60	4.5:1	3+1	570	102.9	12	0.25/515, 0.30/360, 0.35/270, 0.40/210	GR	GR	GR	AL	GR
CB-80	3.8:1	3+1	690	92.5	15	0.40/265, 0.45/210, 0.50/170, 0.55/135	GR	GR	GR	AL	GR



CB-60

DISTANCE DTA

DISTANCE DTA REELS FEATURE:

- 3 +1RB stainless steel bearings
- Quick-Set anti-reverse roller bearing
- Machine cut anodizing alum spool
- Aluminum regular handle
- Hydro block system
- Even flow roller
- Worm shaft transmission system
- Metal line clip
- LCS line control spool



DISTANCE DTA

Model	Gear ratio	Bearings	Weight (g)	Line retrieve (cm)	Max Drag Force (kg)	Monofilament line capacity (diameter in mm.)	Frame	Sideplates	Rotor	Spool
DTA-60	4.5:1	3+1	570	100.3	12	0.25/600, 0.30/420, 0.35/310, 0.40/240	GR	GR	GR	AL



DTA-60

BIG BOMBER SPOD

BIG BOMBER SPOD REELS FEATURE:

- Graphite body construction
- BBD : body blade design
- 3+1 ball bearings
- Quick-Set anti reverse roller bearing
- Machine cut anodized aluminum spool
- 2 round metal line-clips
- Hard metal handle
- TPE Ergo grip handle knob
- XXL Even flow roller
- Worm shaft transmission system
- FPD : Fast Progressive Drag System
- Heavy duty, solid aluminum, anodized bail wire
- RESII: Computer balanced Rotor Equalizing System

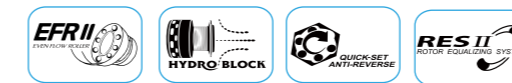

BIG BOMBER SPOD

Model	Gear ratio	Bearings	Weight (g)	Line retrieve (cm)	Max Drag Force (kg)	Monofilament line capacity (diameter in mm.)	Frame	Sideplates	Rotor	Spool
NEW BBS-7000S	4.5:1	3+1	618	103	12	0.20/410, 0.22/340, 0.25/270	GR	GR	GR	AL
BBS-8000S	5.1:1	3+1	720	128	16	0.20/410, 0.22/340, 0.25/270	GR	GR	GR	AL

(BBS-7000S With braided line)



BBS-8000S

INC

INC REELS FEATURES:

- Compact body
- Long Stroke spool 30mm
- Corrosion-resistant graphite body
- 3 ball bearing + 1 roller bearing
- Quick Set infinite anti-reverse system
- Machine cut aluminum spool
- 2 round metal line clips
- Rigid metal handle with wooden knob
- Worm shaft oscillation system
- Machined cut brass pinion gear
- Heavy duty, solid aluminum bail wire
- RESII: Computer-balanced rotor system
- Even Flow line roller
- Rotor brake system
- Fast progressive drag



INC

Model	Gear ratio	Bearings	Weight (g)	Line retrieve (cm)	Max Drag Force (kg)	Monofilament line capacity (diameter in mm.)	Frame	Sideplates	Rotor	Spool
INC-6000	5.3:1	3+1	460	104	12	0.30/370, 0.33/300, 0.35/270	GR	GR	GR	AL
NEW INC-8000	5.3:1	3+1	533	123	16	0.33/440, 0.35/385, 0.38/320	GR	GR	GR	AL



INC-6000



BAITCAST REELS

At Okuma Fishing Tackle we deliver more than fishing gear. We deliver the motivation to hit the water, the energy to maintain focus and the excitement that injects every cast with high expectations. From avid recreational angler to touring professional, Okuma baitcast reels are a step above. Find premium features like Japanese ABEC-5 spool bearings and aluminum gears as standard features in tournament models instead of aftermarket upgrades. Our selection is not simply a platform upon which to begin customization, but the best a reel can be at every price.



KOMODO[®] SS

KOMODO SS LOW PROFILE BAITCAST REELS FEATURE:

- Stainless steel main gear for ultimate power and strength
- Precision machine cut stainless steel pinion gear
- Heavy duty stainless steel drive and spool shafts
- ALC: Rigid diecast aluminum frame and gear sideplate
- CRC: Corrosion-Resistant Coating process
- A6061-T6 machined aluminum, anodized spool
- Multi-disc high output Carbonite drag system
- Micro-click drag star for precise drag settings
- 350 size: 6HPB+1RB corrosion resistant stainless steel bearings
- 450 size: 7HPB+1RB corrosion resistant stainless steel bearings
- Precision Japanese ABEC-5 spool bearings
- Dual anti-reverse for maximum reliability
- Quick-Set anti-reverse roller bearing
- 6-pin Velocity Control casting system
- Synchronized levelwind optimized for braided line
- Zirconium line guide inserts for use with braided line
- Available in both right and left hand retrieve
- On/Off clicker for trolling, chunking or bait fishing from size 300 and up



KOMODO SS LOWPROFILES

Model	Gear ratio	Bearings	Weight (g)	Line retrieve (cm)	Max Drag Force (kg)	Monofilament line capacity (diameter in mm.)	Frame	Right Sideplate	Left Sideplate	Spool
Komodo SS Right hand retrieve with twin paddle handle										
KDS-364	6.4:1	6HPB+1RB	310	78.7	11	0.33/250, 0.37/230, 0.41/150	AL	AL	GR	AL
Komodo left hand retrieve models with twin paddle handle										
KDS-273LX	7.3:1	6HPB+1RB	238	80	9	0.29/205, 0.33/160, 0.37/125	AL	GR	AL	AL
KDS-364LX	6.4:1	6HPB+1RB	310	78.7	11	0.33/250, 0.37/230, 0.41/150	AL	GR	AL	AL
KDS-463LX	6.3:1	7HPB + 1RB	453	85.1	14	0.37/265, 0.42/200, 0.55/115	AL	GR	AL	AL



SERRANO

SERRANO LOW PROFILE BAITCAST REELS FEATURE:

- Rigid, corrosion resistant frame and sideplate construction
- 6BB + 1RB precision stainless steel bearing drive system
- Quick Set anti-reverse bearing for solid hook sets
- Precision cut, high strength brass main and pinion gears
- Externally adjustable magnetic cast control system
- 33.5mm machined aluminum, black anodized spool
- Multi-disc drags washers for consistent performance
- Double paddle, 95mm aluminum swept handle arm
- TGT Grip: Traction Grip Technology



SERRANO LOWPROFILES

Model	Gear ratio	Bearings	Weight (g)	Line retrieve (cm)	Max Drag Force (kg)	Monofilament line capacity (diameter in mm.)	Frame	Right Sideplate	Left Sideplate	Spool
Right Handed Lowprofile Baitcast Reels										
NEW SRN100-A	6.5:1	6+1	199	68	5	0.31/110, 0.33/100, 0.37/80	GR	GR	GR	AL
NEW SRN100H-A	7.2:1	6+1	199	76	5	0.31/110, 0.33/100, 0.37/80	GR	GR	GR	AL
Left Handed Lowprofile Baitcast Reels										
NEW SRN101-A	6.5:1	6+1	199	68	5	0.31/110, 0.33/100, 0.37/80	GR	GR	GR	AL
NEW SRN101H-A	7.2:1	6+1	199	76	5	0.31/110, 0.33/100, 0.37/80	GR	GR	GR	AL

Ceymar

CETMAR LOW PROFILE BAITCAST REELS FEATURE:

- Corrosion-resistant graphite frame and sideplates
- A6061-T6 machined aluminum, anodized U-shaped spool
- Multi-disc composite drag system
- 5BB+1RB bearing drive system
- External adjustable magnetic cast control system
- Quick-Set anti-reverse roller bearing
- Sideplate access port for quick spool changes
- Ergonomic handle design allows cranking closer to body



CEYMAR LOWPROFILES

Model	Gear ratio	Bearings	Weight (g)	Line retrieve (cm)	Max Drag Force (kg)	Monofilament line capacity (diameter in mm.)	Frame	Right Sideplate	Left Sideplate	Spool
Right Handed Lowprofile Reel										
NEW C100-A	6.5:1	5+1	199	68	5	0.31/110, 0.33/100, 0.37/80	GR	GR	GR	AL
NEW C100H-A	7.2:1	5+1	199	76	5	0.31/110, 0.33/100, 0.37/80	GR	GR	GR	AL
Left Handed Lowprofile Reel										
NEW C101-A	6.5:1	5+1	199	68	5	0.31/110, 0.33/100, 0.37/80	GR	GR	GR	AL
NEW C101H-A	7.2:1	5+1	199	76	5	0.31/110, 0.33/100, 0.37/80	GR	GR	GR	AL

SCORPIO

SCORPIO LOW PROFILE BAITCAST REELS FEATURE:

- Corrosion-resistant graphite frame and sideplates
- A6061-T6 machined aluminum, anodized U-shaped spool
- Multi-disc composite drag system
- 5BB+1RB bearing drive system
- External adjustable magnetic cast control system
- Quick-Set anti-reverse roller bearing
- Sideplate access port for quick spool changes
- Ergonomic handle design allows cranking closer to body



SP101-A



SCORPIO LOWPROFILES

	Model	Gear ratio	Bearings	Weight (g)	Line retrieve(cm)	Max Drag Force (kg)	Monofilament line capacity (diameter in mm.)	Frame	Right Sideplate	Left Sideplate	Spool
Right Handed Lowprofile Reel											
NEW	SP100-A	6.5:1	5+1	199	68	5	0.31/110, 0.33/100, 0.37/80	GR	GR	GR	AL
NEW	SP100H-A	7.2:1	5+1	199	76	5	0.31/110, 0.33/100, 0.37/80	GR	GR	GR	AL
Left Handed Lowprofile Reel											
NEW	SP101-A	6.5:1	5+1	199	68	5	0.31/110, 0.33/100, 0.37/80	GR	GR	GR	AL
NEW	SP101H-A	7.2:1	5+1	199	76	5	0.31/110, 0.33/100, 0.37/80	GR	GR	GR	AL

Fuel Spin

FUEL SPIN LOW PROFILE BAITCAST REELS FEATURE:

- Corrosion-resistant graphite frame and sideplates
- A6061-T6 machined aluminum, anodized U-shaped spool
- Multi-disc composite drag system
- 3BB+1RB bearing drive system
- External adjustable magnetic cast control system
- Quick-Set anti-reverse roller bearing
- Sideplate access port for quick spool changes
- Ergonomic handle design allows cranking closer to body



FSP100-A



FUEL SPIN LOWPROFILES

	Model	Gear ratio	Bearings	Weight (g)	Line retrieve(cm)	Max Drag Force (kg)	Monofilament line capacity (diameter in mm.)	Frame	Right Sideplate	Left Sideplate	Spool
Right Handed Lowprofile Reel											
NEW	FSP100-A	6.5:1	3+1	199	68	5	0.31/110, 0.33/100, 0.37/80	GR	GR	GR	AL
NEW	FSP100H-A	7.2:1	3+1	199	76	5	0.31/110, 0.33/100, 0.37/80	GR	GR	GR	AL
Left Handed Lowprofile Reel											
NEW	FSP101-A	6.5:1	3+1	199	68	5	0.31/110, 0.33/100, 0.37/80	GR	GR	GR	AL
NEW	FSP101H-A	7.2:1	3+1	199	76	5	0.31/110, 0.33/100, 0.37/80	GR	GR	GR	AL

CITRIX

CITRIX 350-SIZE REELS FEATURE:

- ALC: Rigid diecast aluminum frame and handle side plate
- A6061-T6 machined aluminum, anodized V-shaped spool
- Multi-disc Carbonite drag system
- 7BB+1RB bearings drive system
- Micro-click drag star for precise drag settings
- External adjustable centrifugal cast control system
- Quick-Set anti-reverse roller bearing
- Zirconium line guide inserts for use with braided line
- Easy change palm side plate access port
- Ergonomic handle design allows cranking closer to body
- 6.4:1 gear ratio available in left hand retrieve

- Graphite sideplates
- Available gear ratios: 6.4:1



Ci-364a



CITRIX LOWPROFILES

	Model	Gear ratio	Bearings	Weight (g)	Line retrieve(cm)	Max Drag Force (kg)	Monofilament line capacity (diameter in mm.)	Frame	Right Sideplate	Left Sideplate	Spool
Citrix 350											
	Ci-364LXa	6.4:1	7+1	312	78.7	11	0.33/250, 0.37/230, 0.41/150	AL	GR	AL	AL





CONVENTIONAL REELS

Leadership, innovation, and value are not simply concepts for board rooms and Powerpoint presentations. At Okuma Fishing Tackle, these guiding principles are embodied and evident in each and every product.

Our engineering embraces modern fishing lines and the latest in fishing rod construction to develop reels that deliver the most power with minimal weight. We're redefining the relationship between size of reel and size of fish, and taking larger trophies on smaller reels than ever before. Our reels don't intrude on the experience, they enhance it.

TESORO

TESORO STAR DRAG REELS FEATURE:

- 6061-T6 machined aluminum frame, sideplate and spool
- 17-4 grade stainless steel helical cut gearing
- Multi-disc Carbonite drag system with Cal's drag grease
- CRC: Corrosion-Resistant Coating Process
- Swept aluminum star for increased ergonomics
- Anodized aluminum swept handle reduces wobble while cranking
- 4BB+1RB corrosion resistant bearings, spool bearing with TSI oil
- Ergo grip handle knob with anodized aluminum handle arm
- Dual anti-reverse (mechanical and roller bearing)
- XL Gearing: Drop down gear box
- Quick-Set ant-reverse bearing allows for zero back play in handle
- MSS: Mechanical Stabilizing System for increased durability
- Self-lubricating gear system, all models
- High Speed 6.2:1 gear ratio



TSR-5S



TSR-10S



TSR-12S



(Additional purchase)



TESORO STAR DRAG REELS

Model	Gear ratio	Bearings	Weight (g)	Line retrieve(cm)	Max Drag Forcr (kg)	Monofilament line capacity (diameter in mm.)	Frame	Sideplates	Spool
TSR-5NS	6.2:1	4+1	445	99	9	0.32/380, 0.35/280, 0.40/200	AL	AL	AL
TSR-5S	6.2:1	4+1	472	99	9	0.35/325,0.40/255,0.45/190	AL	AL	AL
TSR-10S	6.2:1	4+1	540	116.8	10	0.35/390,0.40/290,0.45/225	AL	AL	AL
TSR-12S	6.2:1	4+1	550	116.8	10	0.40/375,0.45/270,0.54/170	AL	AL	AL

Additional Purchase: 120mm Jiggling Handle Assy with T-Bar Handle Knob with Color Box

TSRH-J



CZ-55Wa



CZ-10CSa

CORTEZ

CORTEZ STAR DRAG REELS FEATURE:

- Corrosion resistant graphite frame and sideplates
- CZ-55W features aluminum frame and graphite sideplates
- Machined aluminum, anodized spool
- Multi-disc Carbonite drag system
- Forged aluminum, anodized star
- Anodized aluminum swept handle reduces wobble while cranking
- 4BB+1RB stainless steel bearings
- MCS: External magnetic cast control system on 5CS, 10CS and 12CS sizes
- Ergo grip handle knob
- Dual anti-reverse system (mechanical & roller bearing)
- XL Gearing: Drop down gear box
- Quick-Set anti-reverse roller bearing
- MSS: Mechanical Stabilizing System for increased durability
- Self-lubricating gear system, all models



MCS

Okuma's Magnetic Control System is a fully-sealed, 100% waterproof cast control system that reduces backlash and improves casting distance by utilizing the magnetic field generated by the high RPM spinning of the spool during casting. The magnetic field is influenced by the adjustable cast control magnet which exerts an opposing force and allows for minute and accurate adjustments.



CORTEZ STAR DRAG

Model	Gear ratio	Bearings	Weight (g)	Line retrieve(cm)	Max Drag Force (kg)	Monofilament line capacity (diameter in mm.)	Frame	Side plates	Spool
CZ-5CSa	6.2:1	4+1	396	96.5	7	0.35/370, 0.40/275, 0.45/200	GR	GR	AL
CZ-10CSa	6.2:1	4+1	499	109.2	8	0.40/360, 0.45/270, 0.50/220	GR	GR	AL
CZ-12CSa	6.2:1	4+1	522	109.2	8	0.45/410, 0.50/340, 0.55/280	GR	GR	AL



CONVECTOR

CONVECTOR REELS FEATURE:

- Lightweight corrosion resistant frame and sideplates
- Machined aluminum, gun smoke anodized spool
- Stainless steel reinforcing sideplate rings
- Multi-disc Carbonite drag system
- Ratcheting drag star for precise drag settings
- 2BB+1RB Stainless steel bearing drive system
- Quick-Set anti-reverse roller bearing
- Dual anti-reverse system. (Mechanical & roller bearing)
- Speed Lock pinion gear system
- Durable high-grade brass main and pinion gear system
- XL gearing: Drop down gear box 20, 30, 45 sizes
- Self lubricating gear system, all models
- Wide Mouth levelwind ("L" models): Clearance for copper line
- Ergo grip handle knobs featured on all models
- Stainless steel Body Armor on CV-55L
- MSS: Mechanical Stabilizing System for increased durability



CV-55L

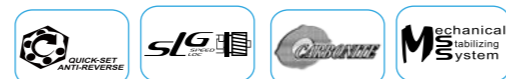

CONVECTOR

Model	Gear ratio	Bearings	Weight (g)	Line retrieve (cm)	Max Drag Force (kg)	Monofilament line capacity (diameter in mm.)	Frame	Sideplates	Spool
Right handed Levelwind reels									
CV-45L	4.0:1	2+1	635	66.0	9	0.45/450, 0.50/360, 0.55/300	GR	GR	AL
CV-55L	4.0:1	2+1	984	86.4	10	0.50/570, 0.55/470, 0.60/400	GR	GR	AL

CONVECTOR

LINE COUNTER

CONVECTOR LINE COUNTER REELS FEATURE:

- Lightweight corrosion resistant frame and sideplates
- Machined aluminum, gun smoke anodized spool
- Stainless steel reinforcing sideplate rings
- Mechanical line counter function measures in feet
- Multi-disc Carbonite drag system
- Ratcheting drag star for precise drag settings
- 2BB+1RB Stainless steel bearing drive system
- Quick-Set anti-reverse roller bearing
- Dual anti-reverse system. (Mechanical & roller bearing)
- Speed Lock pinion gear system
- Durable high-grade brass main and pinion gear system
- XL gearing: Drop down gear box on all models
- Self lubricating gear system, all models
- Wide Mouth levelwind: Clearance for copper line
- Spool stabilizing system for increased durability
- Ergo grip handle knobs featured on all models
- DLX represents left hand crank line counter models
- MSS: Mechanical Stabilizing System for increased durability



CV-30D



CV-20DLX



CONVECTOR LINE COUNTERS

Model	Gear ratio	Bearings	Weight (g)	Line retrieve (cm)	Max Drag Force (kg)	Monofilament line capacity (diameter in mm.)	Frame	Sideplates	Spool
Right handed Linecounter reels									
CV-30D	4.0:1	2+1	610	61.0	7	0.40/420, 0.45/320, 0.50/260	GR	GR	AL
CV-45D	4.0:1	2+1	649	66.0	7	0.45/450, 0.50/360, 0.55/300	GR	GR	AL
Right Handed High Speed Linecounters									
CV-30DS	6.2:1	2+1	584	94.2	7	0.40/420, 0.45/320, 0.50/260	GR	GR	AL
CV-45DS	6.2:1	2+1	638	104.9	7	0.45/450, 0.50/360, 0.55/300	GR	GR	AL
Left handed Linecounter reels									
CV-20DLX	5.1:1	2+1	468	58.4	6	0.35/270, 0.40/210, 0.45/150	GR	GR	AL
CV-30DLX	4.0:1	2+1	610	61.0	7	0.40/420, 0.45/320, 0.50/260	GR	GR	AL



CVT SYSTEM

Clear View Technology anti-fogging line counter

QUICK DROP

QUICK DROP SYSTEM

Quick Drop, switch for precision lure/bait placement

CONVECTOR

CONVECTOR LOWPROFILE LINECOUNTER FEATURE:

- Precision machine cut brass main and pinion gears
- Mechanical line counter function measures in feet
- CVT: Clear View Technology anti-fogging line counter
- 2BB + 1RB stainless steel bearings for long last performance
- Automatic trip, spool engagement mechanism
- A6061-T6 machined aluminum, anodized spool
- Multi-disc high output Carbonite drag system
- Dual anti-reverse for maximum reliability
- Synchronized levelwind optimized for braided line
- Quick Drop, switch for precision lure/bait placement
- Available in both right and left hand retrieve
- On/Off clicker perfect for all trolling applications



CV-354D



CONVECTOR LOWPROFILE LINECOUNTER

Model	Gear ratio	Bearings	Weight (g)	Line retrieve (cm)	Max Drag Force (kg)	Monofilament line capacity (diameter in mm.)	Frame	Left Sideplate	Right Sideplates	Spool
Convector Right hand crank version										
NEW CV-163D	6.3:1	2+1	224	68	5	0.26/240, 0.31/160, 0.37/110	GR	GR	GR	AL
CV-354D	5.4:1	2+1	332	66	10	0.33/240, 0.37/180, 0.41/145	GR	GR	GR	AL
Convector Left hand crank version										
NEW CV-163DLX	6.3:1	2+1	224	68	5	0.26/240, 0.31/160, 0.37/110	GR	GR	GR	AL
CV-354DLX	5.4:1	2+1	332	66	10	0.33/240, 0.37/180, 0.41/145	GR	GR	GR	AL

Cold Water

COLD WATER LINE COUNTER REELS FEATURE:

- Lightweight corrosion resistant frame & sideplates
- Multi-disc, Carbonite drag system
- Aluminum handle arm with Ergo grip handle knobs
- 2BB + 1RB Stainless steel ball bearings
- Quick-set anti-reverse roller bearing
- Oversized machine cut brass XL drive and pinion gears
- Self-lubricating gearing system, all models
- Speed Lock pinion gear system, all models
- Machined aluminum, two tone anodized spool
- Dual anti-reverse system. (Mechanical and roller bearing)
- Mechanical line counter function measures in feet
- CVT: Clear View Technology anti-fogging line counter
- Aluminum ratcheting drag star for precision drag settings
- Wide Mouth levelwind: Clearance for copper lines
- Automatic trip spool engaging mechanism
- MSS: Mechanical Stabilizing System for increased durability
- DLX represent left hand crank line counter models



CW-303D



CW-203D-LE



COLD WATER LINE COUNTERS

Model	Gear ratio	Bearings	Weight (g)	Line retrieve (cm)	Max Drag Force (kg)	Monofilament line capacity (diameter in mm.)	Frame	Sideplates	Spool
Right handed Linecounter reels									
CW-153D	5.1:1	2+1	414	58.4	6	0.35/220, 0.40/170, 0.45/130	GR	GR	AL
CW-203D	5.1:1	2+1	425	58.4	6	0.35/270, 0.40/210, 0.45/150	GR	GR	AL
CW-303D	4.2:1	2+1	567	61.0	7	0.40/420, 0.45/320, 0.50/260	GR	GR	AL
CW-453D	4.2:1	2+1	618	66.0	7	0.45/450, 0.50/360, 0.55/300	GR	GR	AL
Left handed Linecounter reels									
CW-153DLX	5.1:1	2+1	414	58.4	6	0.35/220, 0.40/170, 0.45/130	GR	GR	AL
CW-203DLX	5.1:1	2+1	425	58.4	6	0.35/270, 0.40/210, 0.45/150	GR	GR	AL
CW-303DLX	4.2:1	2+1	567	61.0	7	0.40/420, 0.45/320, 0.50/260	GR	GR	AL
Ladies Edition reels									
CW-203D-LE	5.1:1	2+1	425	58.4	6	0.35/270, 0.40/210, 0.45/150	GR	GR	AL
CW-203DLX-LE	5.1:1	2+1	425	58.4	6	0.35/270, 0.40/210, 0.45/150	GR	GR	AL



Cold Water

COLDWATER COPPER / WIRE LINE REELS

COLDWATER WIRE LINE REELS FEATURE:

- Designed with high speed gear ratios for increased line pickup
- 303/453DS models are high speed line counter reels
- 553LS is a large diameter high speed levelwind reel (no counter)
- Oversized brass XL gearing system
- Multi-disc Carbonite drag washers for maximum efficiency
- 2HPB + 1RB corrosion resistant stainless steel bearings
- Dual anti-reverse system for maximum strength and reliability
- Quick-Set stainless steel anti-reverse roller bearing
- Machined aluminum, anodized spool
- Speed Lock pinion gear system for instant engagement
- Ergo grip handle knob for increased comfort
- Wide Mouth levelwind: Increased knots clearance
- Silent retrieve system for increased smoothness
- MSS: Mechanical Stabilizing System for precise alignment
- XL gearing: Drop down gear box for maximum gear sizing
- Self-lubricating gear system for maximum heat dissipation



COLD WATER WIRELINE AND HIGH SPEED LINECOUNTERS

Model	Gear ratio	Bearings	Weight (g)	Line retrieve (cm)	Max Drag Force (kg)	Monofilament line capacity (diameter in mm.)	Frame	Sideplates	Spool
Right handed High-Speed Linecounter reels									
CW-303DS	6.2:1	2+1	570	94.2	9	0.40/420, 0.45/320, 0.50/260	GR	GR	AL
CW-453DS	6.2:1	2+1	624	104.9	9	0.45/450, 0.50/360, 0.55/300	GR	GR	AL
Right handed High-Speed Levelwind reels									
CW-553LS	4.7:1	2+1	870	103.4	9	0.50/570, 0.55/470, 0.60/400	GR	GR	AL



MAGDA^{PRO} Line Counter

MAGDA PRO LINE COUNTER REELS FEATURE:

- Lightweight, corrosion-resistant frame and side plates
- Corrosion-resistant graphite spools
- Mechanical line counter function measures in feet
- 2 Stainless steel ball bearing
- 16-point anti-reverse for improved hookups
- Line counter screw port for improved air access
- Durable Machine cut brass gearing
- Self-Lubricating Gear System, all models
- 20 - 45 sizes with Ergo grip handle knob design
- 15-size features a twin paddle handle configuration
- Automatic trip spool engaging mechanism
- Stainless steel levelwind line guide system
- DLXT represents left hand crank models
- MA-15DXT-T features a twin paddle handle design



MAGDA PRO DXT LINECOUNTERS



Model	Gear ratio	Bearings	Weight (g)	Line retrieve (cm)	Max Drag Force (kg)	Monofilament line capacity (diameter in mm.)	Frame	Sideplates	Spool
Right handed Linecounter reels									
MA-15DXT-T	5.1:1	2	357	58.4	6	0.35/220, 0.40/170, 0.45/120	GR	GR	GR
MA-20DXT	5.1:1	2	366	58.4	6	0.35/270, 0.40/210, 0.45/150	GR	GR	GR
MA-30DXT	4.0:1	2	457	61.0	7	0.40/420, 0.45/320, 0.50/260	GR	GR	GR
MA-45DXT	4.0:1	2	493	66.0	8	0.45/450, 0.50/360, 0.55/300	GR	GR	GR
Left handed Linecounter reels									
MA-20DLXT	5.1:1	2	366	58.4	6	0.35/270, 0.40/210, 0.45/150	GR	GR	GR
MA-30DLXT	4.0:1	2	457	61.0	7	0.40/420, 0.45/320, 0.50/260	GR	GR	GR
MAGDA DT									
Right handed Linecounter reels									
MA-15DT-T	5.1:1	0	365	58.4	6	0.35/220, 0.40/170, 0.45/130	GR	GR	GR
MA-20DT	5.1:1	0	370	58.4	6	0.35/270, 0.40/210, 0.45/150	GR	GR	GR
MA-30DT	4.0:1	0	460	61.0	7	0.40/420, 0.45/320, 0.50/260	GR	GR	GR
Left handed Linecounter reels									
NEW MA-15DLT	5.1:1	0	365	62	6	0.35/220, 0.40/170, 0.45/130	GR	GR	GR
MA-20DLT	5.1:1	0	370	58.4	6	0.35/270, 0.40/210, 0.45/150	GR	GR	GR
NEW MA-30DLT	4.0:1	0	450	64	7	0.40/420, 0.45/320, 0.50/260	GR	GR	GR

CLASSIC PRO XPD

CLASSIC PRO XPD REELS FEATURE:

- Lightweight corrosion resistant frame and sideplates
- Machined aluminum, anodized spool
- Stainless steel reinforcing sideplate rings
- Mechanical line counter function measures in feet
- Multi-disc Carbonite drag system
- 2 Stainless steel ball bearings
- Durable machine-cut brass gearing
- Ergo Grip handle knob with anodized aluminum handle arm
- Self lubricating gear system, all models
- Stainless steel level-wind line guide system



XPD-30Da



XPD-30DLXa



CLASSIC PRO XPD

Model	Gear ratio	Ball Bearings	Weight (g)	Line retrieve (cm)	Max Drag Force	Monofilament line capacity (diameter in mm.)	Frame	Sideplates	Spool
Right handed Linecounter reels									
XPD-20Da	5.1:1	2	390	58.4	6 kg	0.35/270, 0.40/210, 0.45/150	GR	GR	AL
XPD-30Da	4.0:1	2	500	61.0	7 kg	0.40/420, 0.45/320, 0.50/260	GR	GR	AL
Left handed Linecounter reels									
XPD-20DLXa	5.1:1	2	390	58.4	6 kg	0.35/270, 0.40/210, 0.45/150	GR	GR	AL
XPD-30DLXa	4.0:1	2	500	61.0	7 kg	0.40/420, 0.45/320, 0.50/260	GR	GR	AL

CLASSIC PRO

CLASSIC PRO XP REELS FEATURE:

- Lightweight corrosion resistant frame and sideplates
- Machined aluminum, anodized spool
- Ported graphite frame design
- Stainless steel reel foot for strength
- Dependable multi-disc Rulidium drag system
- Classic Pro XP features 2 ball bearings
- Machine cut brass and stainless steel gearing
- Aluminum power handle with T-style knobs
- Self lubricating gear system
- Stainless steel levelwind line guide system



XP-302La



CLX-452La



CLX-200La

CLX REELS FEATURE:

- Lightweight corrosion resistant frame and sideplates
- Corrosion resistant graphite spools
- Ported graphite frame design
- Stainless steel reel foot for strength
- Dependable multi-disc Rulidium drag system
- CLX features a bushing drive
- Aluminum power handle with T-style knobs
- Self lubricating gear system
- Stainless steel levelwind line guide system



CLASSIC PRO XP AND CLASSIC CLX

Model	Gear ratio	Bearings	Weight (g)	Line retrieve (cm)	Max Drag Force	Monofilament line capacity (diameter in mm.)	Frame	Sideplates	Spool
Classic Pro XP levelwind star drag reels									
XP-302La	3.8:1	2	441	61.0	6 kg	0.40/420, 0.45/320, 0.50/260	GR	GR	AL
XP-452La	3.8:1	2	472	63.5	6 kg	0.45/450, 0.50/360, 0.55/300	GR	GR	AL
Classic CLX Right handed levelwind star drag reels									
CLX-200La	5.1:1	Bushing	333	58.4	5 kg	0.35/270, 0.40/210, 0.45/150	GR	GR	GR
CLX-300La	3.8:1	Bushing	414	61.0	6 kg	0.40/420, 0.45/320, 0.50/260	GR	GR	GR
CLX-450La	3.8:1	Bushing	441	63.5	6 kg	0.45/450, 0.50/360, 0.55/300	GR	GR	GR
Classic CLX Left handed levelwind star drag reels									
CLX-300LXa	3.8:1	Bushing	414	61.0	6 kg	0.40/420, 0.45/320, 0.50/260	GR	GR	GR
Classic Pro CLX Right handed levelwind star drag reels									
CLX-302La	3.8:1	2	438	61.0	6 kg	0.40/420, 0.45/320, 0.50/260	GR	GR	GR
CLX-452La	3.8:1	2	474	63.5	6 kg	0.45/450, 0.50/360, 0.55/300	GR	GR	GR
Classic Pro CLX Left handed levelwind star drag reels									
CLX-302LXa	3.8:1	2	438	61.0	6 kg	0.40/420, 0.45/320, 0.50/260	GR	GR	GR

MAKAIRA REELS WITH TDC DRAG CAMS

MAKAIRA®

DUAL FORCE DRAG SYSTEM

The specialized carbon DFD or Dual Force Drag system used on all Makaira reels was specifically engineered to be mounted in the right side of the spool in order to bring all the mechanical workings closer together to maximize alignment and durability. The farther mechanical parts are separated the more opportunity there is for tolerance error and flexing which causes parts alignment issues. The DFD principal was specifically designed around the "Pull Bar Drag System". The major advantage to a "Pull Bar Drag System" is that the drag is being pulled rather than pushed. The most common type of lever drag in the industry is the "Push Bar Drag System". The Push Bar System places heavy pressure on the left side plate and utilizes the frame for overall stability

which is a fatal flaw in this type of design. This pressure creates frame flex, reducing drag pressure and causing tolerance alignment issues. This problem is further exaggerated on open top designs from other companies. One of the major benefits to the pull bar design is that there is no pressure placed on the frame. Therefore, our open top frame designs will not suffer frame flex found in our competitors reels.

This highly efficient drag system was designed and engineered by Tiburon Engineering USA to increase maximum drag pressure, reduce side load pressure on ball bearings and improve heat dissipation for long term smoothness over extended periods. This Okuma DFD is considered a wet drag system comprised of two carbon fiber drag washers that are sandwiched together and bonded with a fiber glass core. Pure carbon washers are coated with a thin layer of Cal Sheet's Universal drag grease for virtually zero start up inertia. These washers are compressed by two precision ground 17-4 grade stainless steel drag plates that have been ground flat then polished for maximum smoothness. These stainless steel friction drag plates have a minimum 32 Rockwell hardness allowing for high-end drag settings and consistently smooth drag performance at all ranges. The drag system is secured to the right side of the spool by a 6061-T6 grade aluminum cover that features Type-II anodizing for maximum alignment, strength and corrosion resistance.



MK-8II/10II/15II/15TII

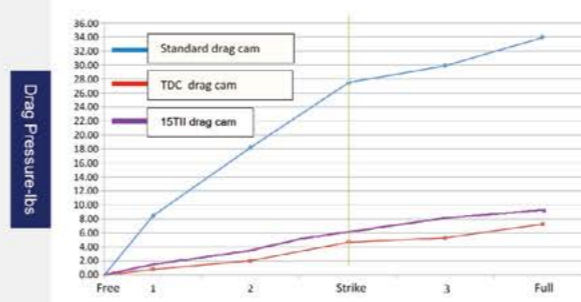

MK8II/10II/15II/15TII-Line class 15 lbs

Drag Lever Position	1	2	Strike	3	Full
Standard drag cam	8.6	18.6	27.3	30.2	34.1
TDC drag cam	0.9	2.1	4.7	5.5	7.0
15TII TDC drag cam	1.5	2.8	4.7	6.2	7.3



MK-16II/20II



MK-30II

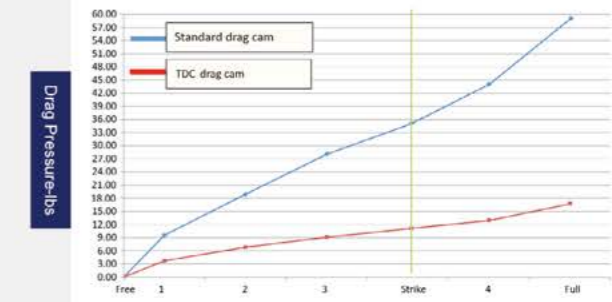

MK16II/20II/30II-Line class 30 lbs

Drag Lever Position	1	2	3	Strike	4	Full
Standard drag cam	10.5	19.2	28.3	38.2	44.6	59.3
TDC drag cam	4.2	7.0	9.1	11.4	13.7	17.5



MK-50II/MK-50WII

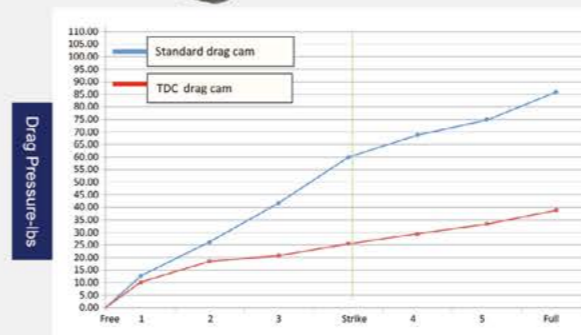

MK50II/50WII-Line class 50 lbs

Drag Lever Position	1	2	3	Strike	4	5	Full
Standard drag cam	12.0	26.1	42.7	59.6	67.6	75.8	86.7
TDC drag cam	10.3	17.7	21.4	26.2	29.1	33.2	38.9



MK-80WII / 130II

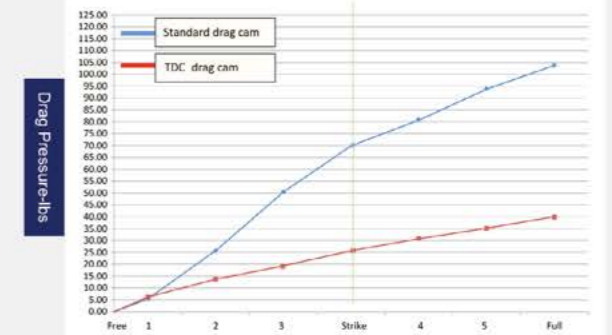

MK80WII/130II-Line class 80 lbs

Drag Lever Position	1	2	3	Strike	4	5	Full
Standard drag cam	4.8	26.5	51.1	69.7	81.0	93.1	103.4
TDC drag cam	5.5	13.6	19.3	26.1	31.0	35.3	39.4

MAKAIRA®

TOURNAMENT DRAG CAM IGFA LINE CLASSES FOR MAKAIRA



TDC-80WII/130II



TDC-50II/50WII



TDC-16II/20II/30II



TDC-8II/10II/15II/15TII

TROLLING REELS



Okuma's TDC or "Tournament Drag Cam" is designed with a more gradual ramp in the cam system that is intended for anglers fishing light line and tournament IGFA line classes. The standard cam that is installed in the Makaira reels is engineered to be compatible with braided line and offers aggressive drag ramps in order to output heavy drag ratings. The Makaira reels are engineered to output extreme drag pressure, but this is not required by all anglers. These reels have been designed to offer customization and with the TDC cam system, Okuma is offering anglers a reel that is versatile for a wide range of fishing applications, allowing anglers the ability to achieve a more gradual increase in drag settings.

Model	Description
TDC-8II/10II/15II/15TII	Makaira Tournament Drag Cam
TDC-16II/20II/30II	Makaira Tournament Drag Cam
TDC-50II/50WII	Makaira Tournament Drag Cam
TDC-80WII/130II	Makaira Tournament Drag Cam



SILENT ANTI-REVERSE:

The Makaira's proprietary anti-reverse system allows for a smoother and quieter feeling. We equate this feeling to that of a Lexus, when compared to other reels in the market. Most reels in the market hide their rough gear quality by the noise and vibration caused by the engagement and clacking of the anti-reverse pawls. The Okuma silent system is unlike any other 2-speed reel in the industry for smoothness. This anti-reverse system is supported by a 12 point double dog anti-reverse pawl system. The Makaira system is very simple in principal but the performance is extremely advanced. As you turn the reel forward the anti-reverse pawls slide open allowing a friction free and quiet retrieve. As soon as the handle is stopped or pulled backwards the anti-reverse pawls are engaged into place by their drive shaft actuated sliding system. The strength of this anti-reverse system does not solely rely on a dog spring like found on most of our competitors reels. The sliding function does not rely heavily on a dog spring system and is mainly controlled by the forward and reverse movement applied to the drive shaft through the movement of the angler turning the handle.



HELICAL CUT GEARING:

Makaira lever drag reels utilize helical cut main and pinion gears. This process allows for improved gear meshing which equates to improved gear smoothness. The angled teeth found in helical cut gears engage more gradually than straight cut or spur gear teeth. This allows helical gears to run smoother and quieter compared to spur gears. Spur gears cause impact stress and noise, because of the hard meshing and can not take as much torque as helical gears because their teeth are receiving impact blows as they mesh together.



GREASE AND OIL:

To further enhance the corrosion resistance of Makaira reels, Okuma applies our CRC or Corrosion Resistant Coating process to all internal and external parts for maximum protection. Our CRC process utilizes a coating process of Corrosion X HD formula that actually penetrates and bonds to the aluminum parts for long term protection. The extra steps taken in the assembly of the Makaira allows this reel to be a leader in the fishing tackle industry for long term use and performance. To further enhance the Makaira's function and performance, Okuma applies Cal's Universal drag grease to our carbon fiber drag washers for the smoothest wet drag system. The addition of Cal's drag grease allows for virtually zero start up inertia and smooth performance at all settings. Cal's Universal grease is also used for coating moving parts such as the main and pinion gears for improved performance.

MAKAIRA

Model	Type of braid	Braided Line Length	Top shot length
Braid Line Capacity for Makaira Reels			
MK-10II	Solid	300-yds of 50-lbs	75 to 100-yds of 20 to 40-lbs
MK-15II	Solid	300-yds of 65-lbs	80 to 100-yds of 30 to 50-lbs
MK-15TII	Solid	450-yds of 80-lbs	15-yds top shot
MK-16II	Hollow Core	600-yds of 100-lbs	50 ft. wind on leader
MK-20II	Hollow Core	700-yds of 100-lbs	50 ft. wind on leader
MK-30II	Hollow Core	800-yds of 100-lbs (HC)	80-yds of 80-lbs
MK-50II	Hollow Core	600-yds of 130-lbs (HC)	50 to 80-yds of 80 to 100-lbs
MK-50WII	Hollow Core	800-yds of 130-lbs (HC)	50 to 80-yds of 80 to 100-lbs
MK-80WII	Hollow Core	1000-yds of 80-lbs (HC)	80 to 100-yds of 130-lbs

TROLLING REELS

MAKAIRA®

MAKAIRA REELS FEATURE:

- 6061-T6 machined aluminum frame with forged side plates
- 17-4 grade stainless steel gearing
- Helical cut gears for increased torque, smoothness and improved gear meshing
- Makaira reels all feature two-speed gearing systems
- Gold anodized two-speed gear shifter housing
- Cold forged, Type-II anodized, machined aluminum spool
- CRC: Corrosion Resistant Coating process
- Patented spool pin system for use with braided or mono lines
- Carbonite Dual Force drag system featuring Cal's universal drag grease
- Custom designed thrust bearing: Alleviates side load on heavy drag settings
- 4-pcs ABEC-5 precision Sapporo stainless steel ball bearings
- MK-80WII features 6-pcs of Sapporo ball bearings
- Double-dog, proprietary silent anti-reverse system
- Ratcheting drag lever and pre-set knob for precise drag setting
- Patented T-Bar handle with Easy Roll graphite insert on all models
- Heavy duty stainless steel ratcheting clicker system
- Heavy duty, 17-4 grade stainless steel drive and spool shafts
- Type-II gold anodized frame, sideplates, spool, drag lever and handle
- Open top frame design on 10II, 15II, 16II, 20II, and 50II
- Lug and plug system on all open top reel models
- Machined thumb rest on rear cross bar for improved ergonomics
- Forged aluminum full hard anodized reel foot and reel clamp
- Machine-etched marlin logo on left side plate
- Precision placement of drain holes maximizes water removal from reel
- Special screw ports around side plate screws reduces water/corrosion buildup



MAKAIRA

Model	Gear ratios	Bearings	Weight (g)	Line retrieve(cm)	Monofilament line capacity (diameter in mm.)	Max Drag @ Strike with Freespool	Max Drag @ Full with Freespool	Frame style	Frame	Sideplates	Spool
Two-Speed Lever Drag Reels											
MK-10II	4.7:1 & 2.1:1	4BB + 1TB	740	85.1 & 38.1	0.37/420, 0.42/350, 0.48/260	12.3 kg	15.4 kg	Topless	AL	AL	AL
MK-15II	4.7:1 & 2.1:1	4BB + 1TB	780	85.1 & 38.1	0.42/500, 0.48/370, 0.55/280	12.3 kg	15.4 kg	Topless	AL	AL	AL
MK-16II	4.3:1 & 1.3:1	4BB + 1TB	1160	99.6 & 30.0	0.42/800, 0.48/600, 0.55/450	15.4 kg	21.7 kg	Topless	AL	AL	AL
MK-20II	3.8:1 & 1.7:1	4BB + 1TB	1298	100.1 & 44.5	0.48/800, 0.55/600, 0.60/480	16.8 kg	25.0 kg	Topless	AL	AL	AL
MK-30II	3.8:1 & 1.7:1	4BB + 1TB	1417	100.1 & 44.5	0.55/700, 0.60/640, 0.70/500	16.8 kg	25.0 kg	Crossbar	AL	AL	AL
MK-50II	3.2:1 & 1.3:1	4BB + 1TB	1741	96.0 & 38.9	0.55/910, 0.70/590, 0.90/360	27.2 kg	39.0 kg	Topless	AL	AL	AL
MK-50WII	3.2:1 & 1.3:1	4BB + 1TB	1843	96.0 & 38.9	0.70/820, 0.75/710, 0.90/510	27.2 kg	39.0 kg	Crossbar	AL	AL	AL
MK-80WII	3.1:1 & 1.2:1	6BB + 1TB	3289	116.1 & 52.9	0.90/910, 1.00/770, 1.12/600	32.1 kg	45.4 kg	Crossbar	AL	AL	AL
MK-130II	2.2:1 & 1.2:1	6BB + 1TB	4750	100.8 & 55.1	0.90/1450, 1.00/1170, 1.12/920	34.1 kg	45.4 kg	Crossbar	AL	AL	AL

MAKAIRA[®] SPECIAL EDITION

MAKAIRA SEa REELS FEATURE:

- Open spool bearings with TSI-301 oil. Increases freespool 2-1/2 times.
- MK80WIISEa and MK-130IIESEa feature grease-packed spool bearings
- All non-spool bearings feature full grease pack for maximum longevity.
- Features Special Edition Gun Smoke and Black anodizing.
- SEa reels feature a yellowfin tuna etched into the sideplate.
- Frames have been machined out for increased clearance between spool and cross bars.
- MK-10/15 feature MK-20 size handle knobs.
- MK-20/30 feature the MK-50 handle arm and knobs
- Lower speed 1.3:1 gear ratio featured in 20/30 sizes.
- Lower speed 1.0:1 gear ratio featured in 50 size.
- Type-II gun smoke anodized frame, side plates and drag lever



MK-15TIIEa-GOLD



MK-10IIEa



MK-15TIIEa



MK-50WIISEa



MK-130IIEa



MK-80WIISEa

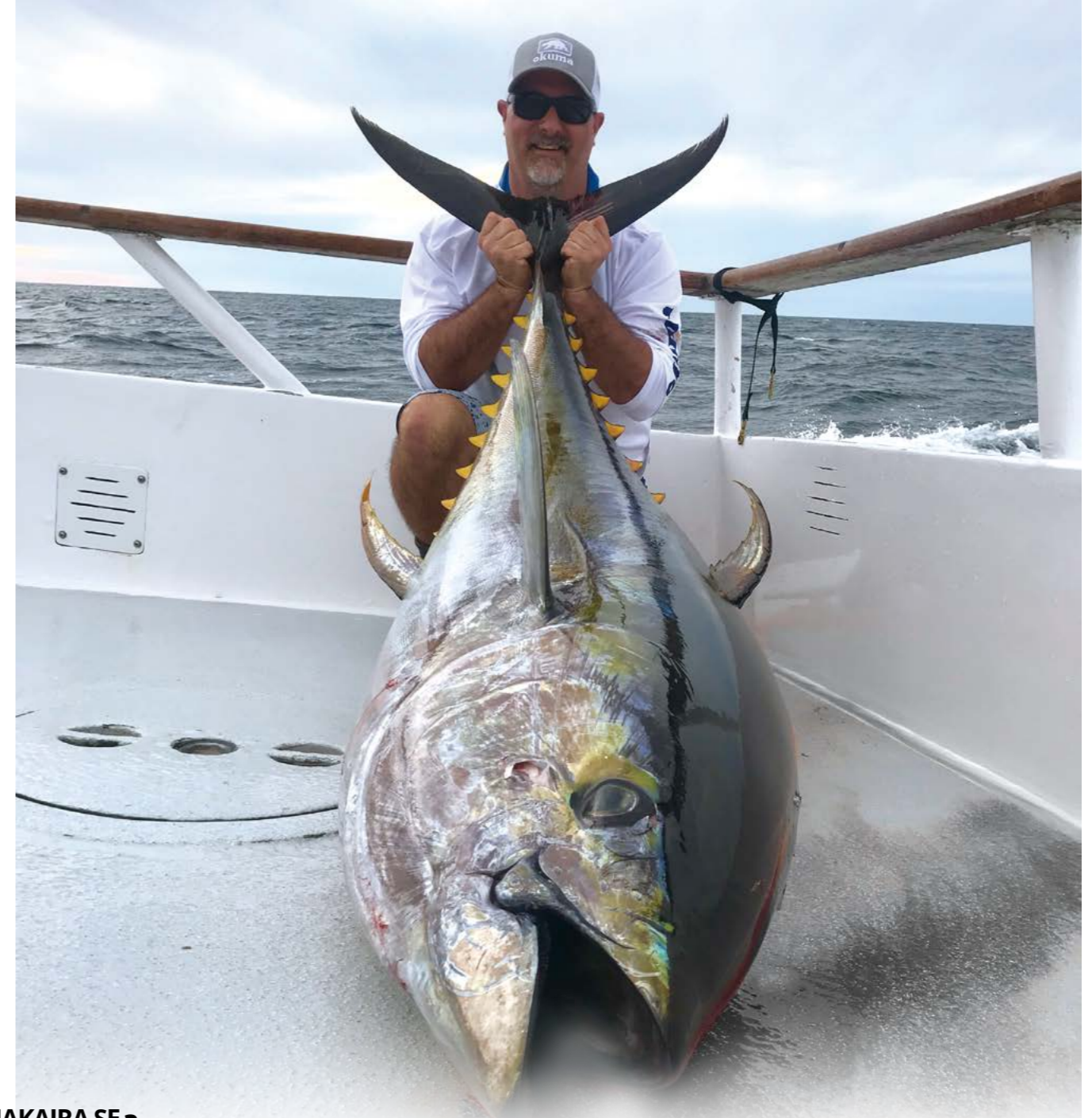

MAKAIRA SEa

Model	Gear ratios	Bearings	Weight (g)	Line retrieve(cm)	Monofilament line capacity (diameter in mm.)	Max Drag @ Strike with Freespool	Max Drag @ Full with Freespool	Frame style	Frame	Sideplates	Spool
Two-Speed Lever Drag Reels											
MK-10IIEa	4.7:1 & 2.1:1	4BB + 1TB	740	85.1 & 38.1	0.37/420, 0.42/350, 0.48/260	12.3 kg	15.4 kg	Topless	AL	AL	AL
MK-15TIIEa	4.7:1 & 2.1:1	4BB + 1TB	822	98.8 & 43.4	0.45/525, 0.48/385, 0.55/295	14.5 kg	18.2 kg	Topless	AL	AL	AL
MK-16IIEa	4.3:1 & 1.3:1	4BB + 1TB	1134	99.6 & 30.0	0.42/800, 0.48/600, 0.55/450	15.4kg	21.7kg	Topless	AL	AL	AL
MK-20IIEa	3.8:1 & 1.3:1	4BB + 1TB	1298	100.1 & 33.5	0.48/800, 0.55/600, 0.60/480	16.8 kg	25.0 kg	Topless	AL	AL	AL
MK-30IIEa	3.8:1 & 1.3:1	4BB + 1TB	1417	100.1 & 33.5	0.55/770, 0.60/640, 0.70/500	16.8 kg	25.0 kg	Topless	AL	AL	AL
MK-50IIEa	3.2:1 & 1.0:1	4BB + 1TB	1707	96.0 & 30.2	0.55/910, 0.70/590, 0.90/360	27.2 kg	39.0 kg	Topless	AL	AL	AL
MK-50WIISEa	3.2:1 & 1.0:1	4BB + 1TB	1843	96.0 & 30.2	0.70/820, 0.75/710, 0.90/510	27.2 kg	39.0 kg	Crossbar	AL	AL	AL
MK-80WIISEa	3.1:1 & 1.2:1	6BB + 1TB	3289	116.1 & 52.1	0.90/910, 1.00/770, 1.12/600	32.1 kg	45.4 kg	Crossbar	AL	AL	AL
MK-130IIEa	2.2:1 & 1.2:1	6BB + 1TB	4750	100.8 & 55.1	0.90/1450, 1.00/1170, 1.12/920	34.1 kg	45.4 kg	Crossbar	AL	AL	AL
Makaira SEa-Gold											
NEW MK-15TIIEa Gold	4.7:1 & 2.1:1	4BB + 1TB	822	98.8 & 43.4	0.45/525, 0.48/385, 0.55/295	14.5 kg	18.2 kg	Topless	AL	AL	AL

MAKAIRA®

MAKAIRA SEa SILVER REELS FEATURE:

- Open spool bearings with TSI-301 oil. Increases freespool 2-1/2 times.
- MK80WII SEa Silver and MK-130II SEa Silver feature grease-packed spool bearings
- All non-spool bearings feature full grease pack for maximum longevity.
- Features Special Edition Silver and Black anodizing.
- SEa reels feature a yellowfin tuna etched into the sideplate.
- Frames have been machined out for increased clearance between spool and cross bars.
- MK-10 feature MK-20 size handle knobs.
- MK-20/30 feature the MK-50 handle arm and knobs
- Lower speed 1.3:1 gear ratio featured in 20/30 sizes.
- Lower speed 1.0:1 gear ratio featured in 50 size.
- Type-II silver anodized frame, side plates and drag lever



MK10II-SEa



MK15TII-SEa



MK30II-SEa



MK16II-SEa



MK20II-SEa



MAKAIRA SEa SILVER

Model	Gear ratios	Bearings	Weight (g)	Line retrieve (cm)	Monofilament line capacity (diameter in mm.)	Max Drag @ Strike with Freespool	Max Drag @ Full with Freespool	Frame style	Frame	Sideplates	Spool
Two-Speed Lever Drag Reels											
MK-10IIEa-Silver	4.7:1 & 2.1:1	4BB + 1TB	740	85.1 & 38.1	0.37/420, 0.42/350, 0.48/260	12.3 kg	15.4 kg	Topless	AL	AL	AL
MK-15TIISEa-Silver	4.7:1 & 2.1:1	4BB + 1TB	822	98.8 & 43.4	0.45/525, 0.48/385, 0.55/295	14.5 kg	18.2 kg	Topless	AL	AL	AL
MK-16IIEa-Silver	4.3:1 & 1.3:1	4BB + 1TB	1134	99.6 & 30	0.42/800, 0.48/600, 0.55/450	15.4 kg	21.7 kg	Topless	AL	AL	AL
MK-20IIEa-Silver	3.8: & 1.3:1	4BB + 1TB	1298	100 & 33.5	0.48/800, 0.55/600, 0.60/480	16.8 kg	25 kg	Topless	AL	AL	AL
MK-30IIEa-Silver	3.8:1 & 1.3:1	4BB + 1TB	1417	100 & 33.5	0.55/770, 0.60/640, 0.70/500	16.8 kg	25 kg	Topless	AL	AL	AL
MK-50IIEa-Silver	3.2:1 & 1.0:1	4BB + 1TB	1707	96 & 30.2	0.55/910, 0.70/590, 0.90/360	27.2 kg	39.0 kg	Topless	AL	AL	AL
MK-50WIISEa-Silver	3.2:1 & 1.0:1	4BB + 1TB	1843	96 & 30.2	0.70/820, 0.75/710, 0.90/510	27.2 kg	39.0 kg	Crossbar	AL	AL	AL
MK-80WIISEa-Silver	3.1:1 & 1.2:1	6BB + 1TB	3289	116.1 & 52.1	0.90/910, 1.00/770, 1.12/600	32.1 kg	45.4 kg	Crossbar	AL	AL	AL
MK-130IIEa-Silver	2.2:1 & 1.2:1	6BB + 1TB	4750	100.8 & 55.1	0.90/1450, 1.00/1170, 1.12/920	34.1 kg	45.4 kg	Crossbar	AL	AL	AL

ALIJOS

ALIJOS LEVER DRAG REELS FEATURE:

- 17-4 grade stainless steel main and pinion gears
- Carbonite Dual Force Drag system with Cal's drag grease
- 6-NMB corrosion resistant stainless steel bearings
- Spool bearings feature TSI-301 oil for unmatched freespool
- Rigid 1-pcs frame and left sideplate construction
- 6061-T6 machined aluminum frame and sideplates
- Cold forged, Type-II anodized, machined aluminum spool
- Silent retrieve system for ultimate cranking smoothness
- 90mm handle arm, increases cranking leverage/power
- Oversized T-Bar handle on all models, for cranking power
- Lug and plug harness system featured on 12 and 16 sizes
- External adjustable cast control system on left sideplate
- CRC: Corrosion Resistant Coating process

ALIJOS HIGH SPEED LEVER DRAG REELS FEATURE:

- Optimized for fishing consistent light drag settings
- Features TDC drag cams for gradual drag curves
- High speed 6.4:1 gear ratios for quick line recovery
- 17-4 grade stainless steel main and pinion gears
- Carbonite Drag system with Cal's drag grease
- 6-NMB corrosion resistant stainless steel bearings
- Dual anti-reverse system (Mechanical and roller bearing)
- QuickSet anti-reverse bearing allows for zero handle back play
- Rigid 1-pcs frame and left sideplate construction
- 6061-T6 machined aluminum frame and sideplates
- Cold forged, Type-II anodized, machined aluminum spool
- Silent retrieve system for ultimate cranking smoothness
- Lug and plug harness system featured on 12 and 16 sizes
- CRC: Corrosion Resistant Coating process



MACHINED RIGID FRAME CONSTRUCTION

Okuma's Machined Rigid Frame construction incorporates a one-piece fully-machined aluminum frame. These rigid bar-stock aluminum frames are the ultimate in precision alignment and tolerances withstanding more pressure and torque than any other material used in our industry for frame materials.



DUAL FORCE DRAG SYSTEM

This drag system is specifically engineered to be mounted in the right side of the spool, designed around a Pull Bar Drag System which keeps all mechanical workings in precise alignment and places no pressure on the frame. This system works in conjunction with a custom designed thrust bearing, which alleviates side load at heavy drag settings.



17-4 GRADE STAINLESS STEEL MAIN AND PINION GEARS

CORROSION RESISTANT COATING-CRC

Okuma applies our CRC or Corrosion Resistant Coating process to all internal and external parts for maximum protection.

Our CRC process utilizes a coating process of Corrosion X HD formula that actually penetrates and bonds to the aluminum parts for long term protection.



ALIJOS

Model	Gear ratios	Bearings	Weight (g)	Line retrieve (cm)	Max Drag Pressure(kg)	Monofilament line capacity (diameter in mm.)	Frame	Left Sideplate	Right Sideplate	Spool
ALIJOS 2-Speed Reels										
NEW AJ-5II	6.4:1 & 3.8:1	6	550	107 & 83	11 & 7	0.32/570, 0.37/400, 0.42/320	AL	AL	AL	AL
NEW AJ-5NII	6.4:1 & 3.8:1	6	530	107 & 63	11 & 7	0.32/385, 0.37/275, 0.42/225	AL	AL	AL	AL
NEW AJ-12II	4.7:1 & 2.1:1	6	800	90 & 40	15.5 & 12.3	0.42/510, 0.48/380, 0.55/290	AL	AL	AL	AL
NEW AJ-12SII	6.4:1 & 2.1:1	6	810	123 & 40	15.5 & 12.3	0.42/510, 0.48/380, 0.55/290	AL	AL	AL	AL
NEW AJ-12NSII	6.4:1 & 2.1:1	6	765	123 & 40	15.5 & 12.3	0.42/300, 0.48/200, 0.55/150	AL	AL	AL	AL
NEW AJ-16II	4.3:1 & 1.3:1	6	995	100 & 30	21.7 & 15.5	0.42/800, 0.48/600, 0.55/450	AL	AL	AL	AL
ALIJOS Single-Speed / Special Edition										
NEW AJ-12S SE	6.4:1	6+1	720	123	4.6 & 2.6	0.42/510, 0.48/380, 0.55/290	AL	AL	AL	AL
NEW AJ-16S SE	6.4:1	6+1	890	149	4.6 & 2.6	0.42/800, 0.48/600, 0.55/450	AL	AL	AL	AL

CAVALLA

CAVALLA LEVER DRAG REELS FEATURE:

- Rigid 1-pcs frame and left sideplate construction
- 6061-T6 Machined aluminum frame and sideplates
- 17-4 grade stainless steel main and pinion gears
- Carbonite drag system with Cal's drag grease
- Cold forged, Type-II anodized, machined aluminum spool
- CRC: Corrosion Resistant Coating process
- 4 BB corrosion resistant stainless steel bearings
- Ergo Grip handle knob with anodized aluminum handle arm
- Silent retrieve system for cranking smoothness
- On/Off bait clicker for all lever drag models



CAVALLA

Model	Gear ratios	Bearings	Weight (g)	Line retrieve (cm)	Max Drag Pressure(kg)	Monofilament line capacity (diameter in mm.)	Frame	Left Sideplate	Right Sideplate	Spool
Cavalla 2-Speed Reels										
CAV-5NII	6.4:1 & 3.8:1	4BB	460	107 & 63	7 & 11	0.32/385, 0.37/275, 0.42/225	AL	AL	AL	AL
CAV-5II	6.4:1 & 3.8:1	4BB	485	107 & 63	7 & 11	0.32/570, 0.37/400, 0.42/320	AL	AL	AL	AL
CAV-12NII	4.7:1 & 2.1:1	4BB	675	90 & 40	12.2 & 15.4	0.42/300, 0.48/200, 0.55/150	AL	AL	AL	AL
CAV-12II	4.7:1 & 2.1:1	4BB	705	90 & 40	12.2 & 15.4	0.42/510, 0.48/380, 0.55/290	AL	AL	AL	AL
Cavalla 2-Speed Left Hand Retrieve										
NEW CAV-5NIIILX	6.4:1 & 3.8:1	4BB	460	107 & 63	7 & 11	0.32/385, 0.37/275, 0.42/225	AL	AL	AL	AL
CAV-5IILX	6.4:1 & 3.8:1	4BB	485	107 & 63	7 & 11	0.32/570, 0.37/400, 0.42/320	AL	AL	AL	AL
CAV-12IILX	4.7:1 & 2.1:1	4BB	705	90 & 40	12.2 & 15.4	0.42/510, 0.48/380, 0.55/290	AL	AL	AL	AL
Cavalla Single-Speed Reels										
CAV-5S	6.4:1	4BB	465	107	7 & 11	0.32/570, 0.37/400, 0.42/320	AL	AL	AL	AL
CAV-5NS	6.4:1	4BB	440	107	7 & 11	0.32/385, 0.37/275, 0.42/225	AL	AL	AL	AL

MACHINED RIGID FRAME CONSTRUCTION

Okuma's Machined Rigid Frame construction incorporates a one-piece fully-machined aluminum frame. These rigid bar-stock aluminum frames are the ultimate in precision alignment and tolerances withstanding more pressure and torque than any other material used in our industry for frame materials.



17-4 GRADE STAINLESS STEEL MAIN AND PINION GEARS



ERGONOMIC DESIGN

The Ergo Grip handle knob is an extremely comfortable oversized handle-knob design for both speed and power. This soft-touch knob has been ergonomically designed to fit in the palm of your hand.





SOLTERRA SLX

SOLTERRA SLX REELS FEATURE:

- Stainless steel main gears, pinion gears and shafts
- Single speed, High-speed and Two-speed models
- Durable corrosion-resistant frame & side plates
- Stainless steel reinforcing side plate rings
- Forged aluminum spool with line indicator rings
- Carbonite drag system with Cal's universal drag grease
- 2 thrust bearings reduce handle turning force be over 50%.
- 5BB+2TB stainless steel shielded bearings 20-50W models
- 5BB+2TB+RB stainless steel shielded bearings 10/15 models
- Double dog, silent anti-reverse on all models
- Dual anti-reverse system on all 10/15 sizes
- Ratcheting drag lever for precise drag setting
- Stainless Steel Body Armor reduces frame flex 20-50W models
- T-Bar handle design on 50W-size
- Ergo Grip comfort handle on all 10 through 30 sizes
- Low profile On/Off clicker with stainless steel wishbone
- Wide-mouth levelwind: Stainless steel with Ti coating "L" models
- High Speed 6.2:1 gear ratios on SLX-10CS and SLX-15CS
- Open top frame design on SLX-10CS and SLX-15CS



SOLTERRA SLX GRAPHITE LEVER DRAGS

Model	Gear ratios	Bearings	Weight (g)	Line retrieve (cm)	Monofilament line capacity (diameter in mm.)	Max Drag @ Strike with Freespool	Max Drag @ Full with Freespool	Frame	Sideplates	Spool
High speed open top frame reels										
SLX-10CS	6.0:1	5BB+2TB+1RB	660	106.7	0.40//380, 0.45/290, 0.50/230	6.8 kg	10 kg	GR	GR	AL
SLX-15CS	6.0:1	5BB+2TB+1RB	697	106.7	0.45/420, 0.50/340, 0.55/280	6.8 kg	10 kg	GR	GR	AL
Standard Single speed Lever Drags (Features closed frame with top cross bar and harness lugs)										
SLX-20	3.5:1	5BB+2TB	984	81.3	0.50/330, 0.55/440, 0.60/370	11.8 kg	15 kg	GR	GR	AL
SLX-30	3.5:1	5BB+2TB	1017	81.3	0.50/700, 0.55/580, 0.60/490	11.8 kg	15 kg	GR	GR	AL
SLX-50W	3.1:1	5BB+2TB	1487	81.3	0.70/640, 0.90/380, 1.00/310	14.5 kg	18 kg	GR	GR	AL
Two-Speed Lever Drags (Features closed frame with top cross bar and harness lugs)										
SLX-20II	3.8:1 & 1.7:1	5BB+2TB	991	88.9 & 38.1	0.50/530, 0.55/440, 0.60/370	11.8 kg	15 kg	GR	GR	AL
SLX-30II	3.8:1 & 1.7:1	5BB+2TB	1017	88.9 & 38.1	0.50/700, 0.55/580, 0.60/490	11.8 kg	15 kg	GR	GR	AL
SLX-50WII	3.1:1 & 1.3:1	5BB+2TB	1510	81.3 & 38.1	0.70/640, 0.90/380, 1.00/310	14.5 kg	18 kg	GR	GR	AL
Levelwind reels										
SLX-10L	4.2:1	5BB+2TB+1RB	596	73.7	0.40/380, 0.45/290, 0.50/230	6.8 kg	10 kg	GR	GR	AL
SLX-15L	4.2:1	5BB+2TB+1RB	644	73.7	0.45/420, 0.50/340, 0.55/280	6.8 kg	10 kg	GR	GR	AL
SLX-20L	3.5:1	5BB+2TB	1034	81.3	0.50/330, 0.55/440, 0.60/370	11.8 kg	15 kg	GR	GR	AL

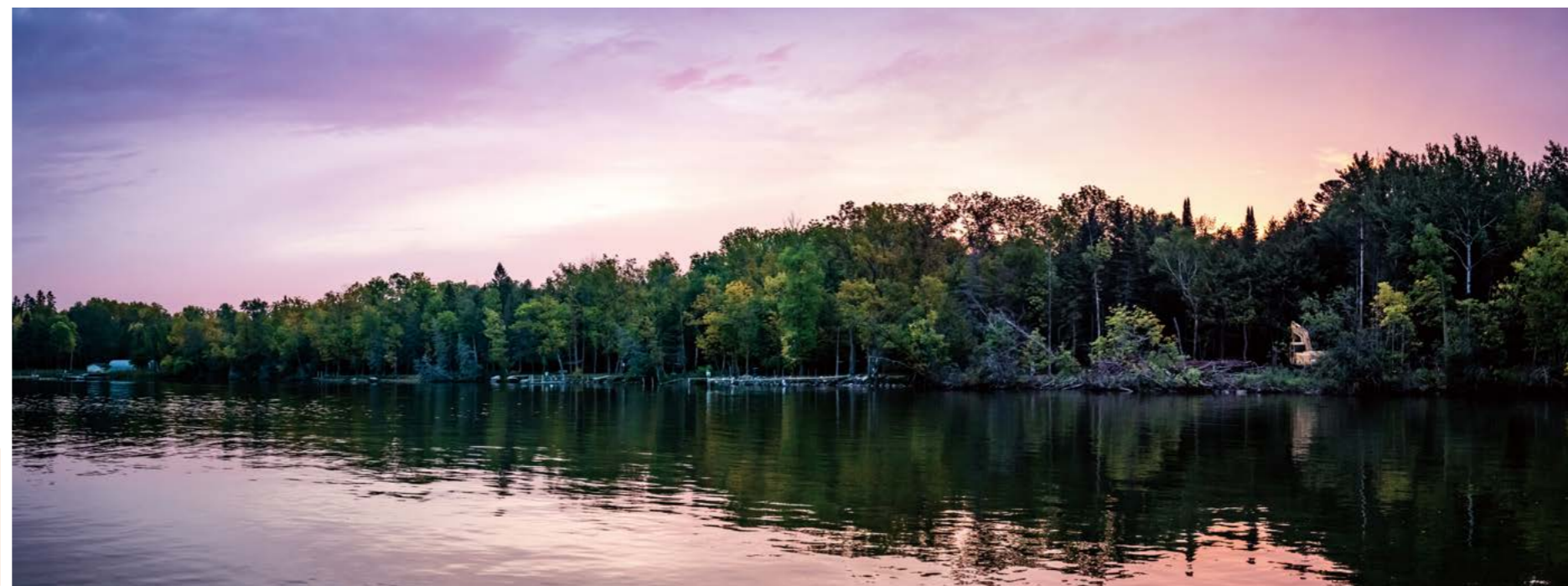

RODS

Nothing inspires the soul like a finely-crafted fishing rod. Upon picking it up, flexing the action and feeling the balance, an angler can immediately visualize the experience- working a bait, feeling the strike, the deep flex under the load of a heavy fish. While the needs of each fishery can be dramatically different, the goal is universally the same: to actively connect with nature as a participant instead of a spectator. With many hundreds of unique rod models covering unique territories, species and techniques, our development process is highly collaborative. We work with the finest anglers in a given discipline to define the performance attributes. Then we bring them to life within our cutting-edge manufacturing facility.



UFR 

TECHNOLOGY

UFR

**Freeing anglers from the choice between
power and sensitivity**

When choosing a rod, anglers often face the trade-off between a powerful but bulky rod that can catch big-sized fish, or a sensitive but weaker rod that can sense the bite of the smallest fish. We address this challenge with a revolutionary tip: Ultimate Flex Reinforcement (UFR), which redefines the future generation of rods.

Developed using a patented manufacturing process, the UFR tip combines strength and agility like never before, marking a breakthrough. Our UFR technology endows our rods with a 300% increase in lifting capability and an ability to bend up to 360°. With longitudinal fibers around the rod blanks, our rods are more powerful, yet lighter and more flexible than traditional ones. As a result, our anglers no longer need to choose between power and sensitivity.

TECHNOLOGY

UMR

LIGHTWEIGHT STRENGTH BUILT FOR ANY CHALLENGE

Okuma's Ultimate Matrix Reinforcement (UMR) technology maximizes rod strength while minimizing weight, so you can rise to meet any challenge.



UMR 

HELIOS *Air*

HELIOS AIR RODS FEATURE:

- 40T+46T Toray carbon with Okuma UMR blank construction
- UMR: Ultimate Matrix Reinforcement
- New exclusive Psychedelic blank artwork
- Seaguide ONE GUIDE design, SS316 stainless steel and tangle-free guides with zirconium inserts
- Okuma Unique tooling skeleton reel seat, Japan carbon injection, with Psychedelic carbon tube body
- Durable Winn grip design
- Split grip butt design for reduced weight and improved balance
- High quality rods bag
- 2-sec all-round rods from 7'0" up to 9'0", 5-18g ultra-light up to more power predator 80-150g
- 4-sec City Park travel rods are also available



HELIOS AIR

	Model	Rod Power	Length	Sections	Lure Wt. (g)	Foregrip length (mm)	Reargrip Length (mm)	Number of Guide	Handle Style	Weight (g)
Spinning Rods										
NEW	HSA-S-702ML	ML	7'0" / 213cm	2-pcs	5-18	45	275	7+Tip	A	105
NEW	HSA-S-702M	M	7'0" / 213cm	2-pcs	7-25	45	275	7+Tip	A	110
NEW	HSA-S-702MH	MH	7'0" / 213cm	2-pcs	12-40	45	275	7+Tip	A	113
NEW	HSA-S-702H	H	7'0" / 213cm	2-pcs	20-60	45	285	7+Tip	A	119
NEW	HSA-S-702XH	XH	7'0" / 213cm	2-pcs	40-80	45	285	7+Tip	A	129
	HSA-S-742MH	MH	7'4" / 224cm	2-pcs	20-50	40	305	8+Tip	A	107
NEW	HSA-S-802ML	ML	8'0" / 244cm	2-pcs	8-30	45	295	8+Tip	A	117
NEW	HSA-S-802M	M	8'0" / 244cm	2-pcs	14-40	45	285	8+Tip	A	122
	HSA-S-802MH	MH	8'0" / 244cm	2-pcs	20-50	45	305	8+Tip	A	128
	HSA-S-802H	H	8'0" / 244cm	2-pcs	30-70	45	305	8+Tip	A	135
NEW	HSA-S-802XH	XH	8'0" / 244cm	2-pcs	40-90	70	420	7+Tip	B	144
NEW	HSA-S-862XH	XH	8'6" / 259cm	2-pcs	50-110	70	440	8+Tip	B	158
NEW	HSA-S-862XXH	XXH	8'6" / 259cm	2-pcs	80-150	70	440	8+Tip	B	171
NEW	HSA-S-902MH	MH	9'0" / 274cm	2-pcs	20-60	45	335	8+Tip	A	147
	HSA-S-902H	H	9'0" / 274cm	2-pcs	30-70	45	335	8+Tip	A	153
City Park Travel Rod										
NEW	HSA-S-704M	M	7'0" / 213cm	4-pcs	7-25	45	275	7+Tip	C	122
NEW	HSA-S-704MH	MH	7'0" / 213cm	4-pcs	12-40	45	275	8+Tip	C	128
NEW	HSA-S-804MH	MH	8'0" / 244cm	4-pcs	20-50	45	305	8+Tip	C	138



ONE.rod

ONE RODS FEATURE:

- Ultra light 40T carbon blank construction
- Fuji anti-tangle stainless steel guides frame
- Fuji Alconite guide inserts reduce friction
- Fuji mini split reel seat
- Okuma carbon cone handle design
- High quality cloth bag package



ONE ROD

Model	Rod Power	Length	Sections	Casting Wt. (g)	Foregrip length	Reargrip Length (mm)	Number of Guide	Handle Style	Weight (g)
Casting Rods									
OR-C-661ML	ML	6'6" / 198cm	1-pc	7-20	N/A	300	9+Tip	B	86
OR-C-661M	M	6'6" / 198cm	1-pc	10-30	N/A	300	9+Tip	B	92
Spinning Rods									
OR-S-661ML	ML	6'6" / 198cm	1-pc	7-20	N/A	280	7+Tip	A	82
OR-S-661M	M	6'6" / 198cm	1-pc	10-30	N/A	280	7+Tip	A	89
OR-S-661MH	MH	6'6" / 198cm	1-pc	15-45	N/A	280	7+Tip	A	95





INSPIRA

INSPIRA RODS FEATURE:

- 30-Ton ultra-light carbon black construction
- Fuji stainless steel top with Alconite inserts
- Seaguide XO anti-tangle 316-stainless steel guides
- Okuma tooling reel seat with Fuji cushioned stainless steel Hood
- Okuma carbon cone concept handle
- Durable EVA with flat aluminum end cap improved balance
- High quality cloth bag packake



INSPIRA

Model	Rod Power	Length	Sections	Casting Wt. (g)	Foregrip length	Reargrip Length (mm)	Number of Guide	Weight (g)
ISP-S-662UL	UL	6'6" / 198cm	2-pcs	0-7	N/A	260	7+Tip	128
ISP-S-702UL	UL	7'0" / 213cm	2-pcs	0-10	N/A	260	8+Tip	134
ISP-S-762UL	UL	7'6" / 229cm	2-pcs	2-12	N/A	290	8+Tip	142
ISP-S-802UL	UL	8'0" / 244cm	2-pcs	2-12	N/A	300	8+Tip	149
ISP-S-902UL	UL	9'0" / 274cm	2-pcs	2-12	N/A	340	9+Tip	163



HELIOS SX

HELIOS SX RODS FEATURE:

- 30T carbon construction
- Slim blanks with fast action
- Japanese split EVA handles
- Ergonomic touch blank screw up reel seat
- CCS SIC gunsmoke guides
- Customized Okuma butt cap
- Delivered in cloth bag



Award winning Helios SX rod comes in 16 different spin models and one trigger model covering all your spinning needs from 2-8 gr 165 cm ultra light fishing to 20-60 gr 300cm jiggging rod.



HELIOS SX

Model	Rod Power	Length	Sections	Lure Wt. (kg)	Foregrip length (mm)	Reargrip Length (mm)	Number of Guide	Handle Style	Weight (g)
Spinning Rods									
HSX-S-562L	L	5'6" / 168cm	2-pcs	2-8	35	230	6+Tip	A	88
HSX-S-602L	L	6'0" / 183cm	2-pcs	2-10	35	230	6+Tip	A	90
HSX-S-662ML	ML	6'6" / 198cm	2-pcs	7-18	35	260	6+Tip	A	95
HSX-S-702L	L	7'0" / 213cm	2-pcs	4-15	35	260	7+Tip	A	95
HSX-S-702ML	ML	7'0" / 213cm	2-pcs	8-20	35	260	7+Tip	A	104
HSX-S-702M	M	7'0" / 213cm	2-pcs	10-30	35	260	7+Tip	A	118
HSX-S-742ML	ML	7'4" / 224cm	2-pcs	8-25	35	260	7+Tip	A	105
HSX-S-742M	M	7'4" / 224cm	2-pcs	12-35	35	280	7+Tip	A	116
HSX-S-742MH	MH	7'4" / 224cm	2-pcs	20-50	35	280	7+Tip	A	124
HSX-S-802ML	ML	8'0" / 244cm	2-pcs	8-25	35	280	8+Tip	A	113
HSX-S-802M	M	8'0" / 244cm	2-pcs	15-40	35	280	8+Tip	A	123
HSX-S-802MH	MH	8'0" / 244cm	2-pcs	20-50	35	280	8+Tip	A	135
HSX-S-902ML	ML	9'0" / 274cm	2-pcs	8-25	35	280	8+Tip	A	128
HSX-S-902M	M	9'0" / 274cm	2-pcs	15-45	35	280	8+Tip	A	144
HSX-S-902MH	MH	9'0" / 274cm	2-pcs	20-60	35	310	8+Tip	A	154
HSX-S-1002M	M	10'0" / 305cm	2-pcs	20-50	35	370	9+Tip	A	162
Casting Rods									
HSX-C-662ML	ML	6'6" / 198cm	2-pcs	7-18	40	275	9+Tip	B	99
Travel Spin Rods									
HSX-S-704ML	ML	7'0" / 213cm	2-pcs	5-20	35	260	7+Tip	A	107
HSX-S-704M	M	7'0" / 213cm	2-pcs	10-30	35	260	7+Tip	A	115
HSX-S-704MH	MH	7'0" / 213cm	2-pcs	15-40	35	260	7+Tip	A	124
HSX-S-804MH	MH	8'0" / 244cm	2-pcs	15-50	35	280	8+Tip	A	137
HSX-S-804H	H	8'0" / 244cm	2-pcs	20-80	35	280	8+Tip	A	150
Travel Casting Rods									
HSX-C-704H	H	7'0" / 213cm	2-pcs	20-60	45	305	10+Tip	B	135



EPIXOR

EPIXOR RODS FEATURE:

- Unique use of Bopp (Biaxially Oriented Polypropylene) Blank protect Film
- Bopp are a 2 way stretch film, which protect the carbon blank from damage, during use and transportation
- Bopp can be recycled
- 30/36-Ton carbon, ultra-light, slim and balanced blanks
- Seaguide XO anti-tangle 316-stainless steel guides
- Zirconium guides inserts reduce friction from braided lines
- Unique light weight ergonomic touch blank reel seats
- AAA cork quality handles
- Durable rubber cork end cap for the balance
- Luxury velvet rod bag



EPIXOR

Model	Rod Power	Length (cm)	Sections	Casting Wt.(g)	Foregrip length (mm)	Reargrip Length (mm)	Number of Guide	Weight (g)
Spinning Rods								
EPI-S-662L-1	L	198	2-pcs	2-12	40	250	6+Tip	97
EPI-S-702L-1	L	210	2-pcs	3-18	40	250	7+Tip	104
EPI-S-742M-1	M	228	2-pcs	10-32	40	270	7+Tip	121
EPI-S-802L-1	L	240	2-pcs	5-20	40	290	7+Tip	123
EPI-S-802ML-1	ML	249	2-pcs	10-32	40	290	7+Tip	133
EPI-S-862M-1	M	258	2-pcs	15-40	40	300	8+Tip	154
EPI-S-902L-1	L	270	2-pcs	5-25	40	340	8+Tip	137
NEW EPI-S-902ML-1	ML	270	2-pcs	10-32	40	340	8+Tip	150
NEW EPI-S-902M-1	M	270	2-pcs	15-50	40	340	8+Tip	171
NEW EPI-S-902MH-1	MH	270	2-pcs	30-70	40	340	8+Tip	189
EPI-S-922ML-1	ML	276	2-pcs	10-32	40	340	8+Tip	158
EPI-S-962M-1	M	288	2-pcs	15-50	40	350	8+Tip	188
EPI-S-1002ML-1	ML	300	2-pcs	10-40	40	380	8+Tip	187
EPI-S-1153M-1	M	345	3-pcs	20-50	40	455	10+Tip	236

EPIXOR Travel rods

EPIXOR TRAVEL RODS FEATURE:

- Unique use of Bopp (Biaxially Oriented Polypropylene) Blank protection Film
- Bopp is a 2 way stretch film, that protect the carbon blank from damage, during use and transportation
- Bopp can be recycled
- Slim, Light and Balanced blanks
- 30 and 36T Korean carbon material
- Unique Light wieht ergonomic touch blank reel seats
- AAA grade cork handles
- Coil control guide system



EPIXOR TRAVEL ROD

Model	Rod Power	Length (cm)	Sections	Lure Wt. (g)	Foregrip length (mm)	Reargrip Length (mm)	Number of Guide	Weight (g)
EPI-S-904L	L	270	4-pcs	7-24	40	340	8+Tip	143
EPI-S-924ML	ML	276	4-pcs	8-28	40	340	8+Tip	152
EPI-S-964ML	ML	288	4-pcs	10-32	40	350	8+Tip	170
EPI-S-1004ML	ML	300	4-pcs	10-36	40	380	8+Tip	199
EPI-S-1154ML	ML	345	4-pcs	10-35	40	455	10+Tip	229



Ceymar SPR

CEYMAR SPR FEATURE:

- Ultra-sensitive and responsive carbon blank construction
- Spiral Carbon technology improves strength and durability
- Quality stainless steel frame guides with Polished Titanium Oxide inserts
- Okuma graphite reel seat with cushioned stainless steel hood
- Ergonomic shaped, split EVA handles
- Durable rubber cork end cap for the rods balance
- Supplied with a quality rod bag



CEYMAR SPR

Model	Rod Power	Length (cm)	Sections	Lure Wt. (g)	Foregrip length (mm)	Reargrip Length (mm)	Number of Guide	Weight (g)
CSPR-S-702H	H	210	2-pcs	30-120	40	300	6+Tip	167
CSPR-S-802H	H	240	2-pcs	30-120	40	350	6+Tip	182
CSPR-S-902H	H	270	2-pcs	30-120	40	380	6+Tip	204
CSPR-S-1002H	H	300	2-pcs	30-120	40	410	7+Tip	231



Pink Pearl V2

PINK PEARL V2 FEATURE:

- 24T carbon construction
- SIC guides silver frame
- Modern graphite screw reel seat
- Okuma butt cap logo
- Designed to match to Pink Pear V2 reels
- Supplied with a quality rod bag



PINK PEARL V2

Model	Rod Power	Length (cm)	Sections	Lure Wt. (g)	Foregrip length (mm)	Reargrip Length (mm)	Number of Guide	Weight (g)
PP-S-712ML V2	ML	213	2-pcs	5-20	35	260	6+Tip	124
PP-S-822M V2	M	249	2-pcs	10-32	35	280	7+Tip	168

AZAKI

AZAKI FEATURE:

- 2 4T Carbon EPC process
- Same blank as Altera
- 3 split handle EVA & Cork
- SIC guides silver frame
- Graphite screw down reel seat with cushions
- Designed to match Azaki spinning reels
- Supplied with a quality rod bag



AZAKI

Model	Rod Power	Length (cm)	Sections	Lure Wt. (g)	Foregrip length (mm)	Reargrip Length (mm)	Number of Guide	Weight (g)
AZK-S-602ML	ML	183	2-pcs	4-12	40	235	5+Tip	88
AZK-S-602M	M	183	2-pcs	5-20	40	235	5+Tip	90
AZK-S-662L	L	198	2-pcs	7-22	40	255	5+Tip	94
AZK-S-702ML	ML	213	2-pcs	5-20	40	270	6+Tip	104
AZK-S-702M	M	213	2-pcs	10-30	40	270	6+Tip	108
AZK-S-762ML	ML	228	2-pcs	8-25	40	270	6+Tip	112
AZK-S-762M	M	228	2-pcs	12-35	40	270	6+Tip	118
AZK-S-802ML	ML	244	2-pcs	7-28	40	290	7+Tip	121
AZK-S-802M	M	244	2-pcs	12-35	40	290	7+Tip	124
AZK-S-902ML	ML	274	2-pcs	7-28	40	290	7+Tip	130
AZK-S-902M	M	274	2-pcs	12-35	40	290	7+Tip	138
AZK-S-902H	H	274	2-pcs	20-60	40	370	7+Tip	165
NEW AZK-S-962ML	ML	286	2-pcs	7-28	40	350	9+Tip	143
NEW AZK-S-1002ML	ML	305	2-pcs	10-30	40	350	9+Tip	158

ALARIS

ALARIS RODS FEATURE:

- 24T Korean carbon blank construction
- Light weight SIC guide system
- Ergonomic, touch blank reel seat
- FC-Full cork handles
- Japanese split handle style
- Supplied in rod bag



ALARIS

Model	Rod Power	Length (cm)	Sections	Casting Wt. (g)	Foregrip length (mm)	Reargrip Length (mm)	Number of Guide	Handle Style	Weight (g)
Casting									
ALA-C-632ML	ML	190	2-pcs	5-22	50	300	8+Tip	A	121
ALA-C-632M	M	190	2-pcs	10-32	50	300	8+Tip	A	123
Spinning									
ALA-S-602L	L	182	2-pcs	2-7	40	240	4+Tip	B	102
ALA-S-612ML	ML	185	2-pcs	5-15	40	260	4+Tip	B	103
ALA-S-632M	M	190	2-pcs	10-32	40	290	4+Tip	B	119
ALA-S-712M	M	215	2-pcs	10-32	40	290	4+Tip	B	118
ALA-S-712ML	ML	215	2-pcs	5-22	40	290	4+Tip	B	147
ALA-S-742M	M	223	2-pcs	10-32	40	310	4+Tip	B	133
ALA-S-742MH	MH	223	2-pcs	15-40	40	330	4+Tip	B	146
ALA-S-822ML	ML	248	2-pcs	10-32	40	330	5+Tip	B	183
ALA-S-862MH	MH	259	2-pcs	20-60	40	380	5+Tip	B	221
ALA-S-902ML	ML	274	2-pcs	7-28	40	380	5+Tip	B	182
ALA-S-1012M	M	307	2-pcs	15-45	40	410	5+Tip	B	216



ALARIS

ALARIS ROD FEATURE:

- 24T carbon construction
- Slim blanks with fast action
- SCT Solid Carbon Tip on Light Jig versions
- Rubber cork butt
- Ergonomic touch reel seat
- CCS SIC gunsmoke guides
- Delivered in cloth bag



ALARIS

Model	Rod Power	Length (cm)	Sections	Lure Wt. (g)	Foregrip length (mm)	Reargrip Length (mm)	Number of Guide	Weight (g)
Light Jig Spin								
ALS-S-802UL	UL	240	2-pcs	up to 12	40	240	7+Tip	131
ALS-S-902UL	UL	270	2-pcs	up to 15	40	250	8+Tip	151
Soft Lure Spin								
ALS-S-802L	L	240	2-pcs	5-15	40	240	7+Tip	134
ALS-S-902L	L	270	2-pcs	5-15	40	250	8+Tip	154
ALS-S-802ML	ML	240	2-pcs	7-25	40	240	7+Tip	138
ALS-S-902ML	ML	270	2-pcs	7-28	40	300	8+Tip	160
Zander Spin								
ALS-S-802M	M	240	2-pcs	10-35	40	260	7+Tip	148
ALS-S-902M	M	270	2-pcs	10-35	40	300	8+Tip	173

ALTERA

ALTERA RODS FEATURE:

- 24T carbon construction
- Slim blanks with fast action
- Japanese split EVA handles
- Ergonomic touch blanks reel seat
- Quality SIC gunsmoke frame guides
- Delivered in cloth bag



ALTERA

Model	Rod Power	Length (cm)	Sections	Lure Wt. (g)	Foregrip length (mm)	Reargrip Length (mm)	Number of Guide	Weight (g)
Spin								
ALT-S-502UL	UL	150	2-pcs	2-7	33	205	5+Tip	82
ALT-S-562L	L	165	2-pcs	3-8	33	235	5+Tip	87
ALT-S-602UL	UL	180	2-pcs	2-7	33	245	5+Tip	93
ALT-S-602L	L	180	2-pcs	4-12	33	245	5+Tip	96
ALT-S-602ML	ML	180	2-pcs	5-20	33	245	5+Tip	98
ALT-S-662ML	ML	195	2-pcs	7-22	33	260	5+Tip	107
ALT-S-662M	M	195	2-pcs	10-30	33	260	5+Tip	110
ALT-S-662MH	MH	195	2-pcs	15-40	33	260	5+Tip	115
ALT-S-662H	H	195	2-pcs	25-70	33	260	6+Tip	130
ALT-S-702ML	ML	210	2-pcs	5-20	33	265	6+Tip	116
ALT-S-702M	M	210	2-pcs	10-30	33	265	6+Tip	118
ALT-S-702MH	MH	210	2-pcs	15-40	33	265	6+Tip	127
ALT-S-702H	H	210	2-pcs	20-60	33	275	6+Tip	135
ALT-S-742ML	ML	228	2-pcs	8-25	33	275	6+Tip	116
ALT-S-742M	M	228	2-pcs	12-35	33	275	6+Tip	119
ALT-S-742MH	MH	228	2-pcs	20-40	33	275	6+Tip	130
ALT-S-802ML	ML	240	2-pcs	7-28	33	285	7+Tip	129
ALT-S-802M	M	240	2-pcs	15-40	33	285	7+Tip	135
ALT-S-802MH	MH	240	2-pcs	20-45	33	285	7+Tip	144
ALT-S-802H	H	240	2-pcs	30-80	33	340	7+Tip	152
ALT-S-902ML	ML	270	2-pcs	5-25	33	285	7+Tip	147
ALT-S-902M	M	270	2-pcs	15-40	33	285	7+Tip	149
ALT-S-902MH	MH	270	2-pcs	20-80	33	360	7+Tip	164
ALT-S-902H	H	270	2-pcs	30-100	33	360	7+Tip	176
ALT-S-1002MH	MH	300	2-pcs	25-70	33	415	8+Tip	187
Casting								
ALT-C-662M	M	195	2-pcs	10-30	33	300	8+Tip	114
ALT-C-662H	H	195	2-pcs	20-50	33	300	8+Tip	129

ALTERA

ALTERA TRAVEL RODS FEATURE:

- 24T carbon blank construction
- 4-pc travel rod concept
- Fast action
- Matt gunsmoke frame SIC K-type guides
- Japanese Split EVA handle
- Modern Ergonomic touch blanks reel seat
- Supplied with a quality rod bag



ALTERA

Model	Rod Power	Length (cm)	Sections	Lure Wt. (g)	Foregrip length (mm)	Reargrip Length (mm)	Number of Guide	Handle Style	Weight (g)
Travel Spin									
ALT-S-704MH	MH	213	4-pcs	15-40	35	275	6+Tip	A	129
ALT-S-704H	H	213	4-pcs	20-60	35	285	6+Tip	A	138
ALT-S-704XH	XH	213	4-pcs	30-80	35	285	6+Tip	A	145
ALT-S-804H	H	244	4-pcs	40-80	35	350	7+Tip	A	167
Travel Casting									
ALT-C-704H	H	213	4-pcs	20-60	35	300	8+Tip	B	145
ALT-C-704XH	XH	213	4-pcs	30-80	35	300	8+Tip	B	151



ALTERA TELE SPIN

ALTERA TELE SPIN RODS FEATURE:

- 24T ultra-light carbon blank construction
- Slim blanks with fast action
- Matt gunsmoke frame SIC guides
- Okuma graphite reel seat
- Aluminum screw end cap with non-skid rubber
- Quality guide cover and cloth bag included



ALTERA

Model	Rod Power	Length (cm)	Sections	Lure Wt. (g)	Foregrip length (mm)	Reargrip Length (mm)	Number of Guide	Weight (g)
Tele Spin								
ATE-S-605M-T	M	183	5-pcs	10-30	35	235	3+Tip	102
ATE-S-705M-T	M	213	6-pcs	10-30	35	250	4+Tip	116
ATE-S-806M-T	M	244	7-pcs	15-40	35	265	5+Tip	133
ATE-S-907M-T	M	274	7-pcs	15-40	35	310	6+Tip	147
ATE-S-1007M-T	M	305	7-pcs	15-40	35	345	6+Tip	182
ATE-S-1107M-T	M	330	7-pcs	20-50	35	360	6+Tip	211



VS System G2

VSYSTEM G2 RODS FEATURE:

- Ultra-light high modulus carbon blank construction
- Quality anti tangle stainless steel frame guides
- Okuma graphite reel seat
- Ergonomic shaped, hard EVA handles
- EVA split grip and EVA fore grip for reduced weight and feel
- Aluminum screw end cap with non-skid rubber
- Quality guide cover and cloth bag included



VSYSTEM G2

Model	Rod Power	Length (cm)	Sections	Casting Wt. (g)	Foregrip length (mm)	Reargrip Length (mm)	Number of Guide	Weight (g)
VST-S-806M-T	M	240	6-Tele	10-40	40	305	5+TIP	163
VST-S-907M-T	M	270	7-Tele	10-40	40	360	6+TIP	179
VST-S-1007M-T	M	300	7-Tele	10-40	50	425	6+TIP	186



NEMESIS RODS FEATURE:

- High modulus ultra-light carbon blank construction
- Quality stainless steel frame guides
- Okuma graphite reel seat
- EVA split grip and EVA fore grip for reduced weight and feel
- Aluminum end cap with Okuma epoxy logo
- Travel Cast available in 6'0"



NEMESIS

Model	Rod Power	Length	Sections	Casting Wt. (g)	Line Wt. (lbs)	Foregrip length (mm)	Reargrip Length (mm)	Number of Guide	Handle Style	Weight (g)
Casting										
NE-C-562L	L	5'6" / 168cm	2-pcs	5-10	4-10	50	220	7+Tip	A	107
NE-C-602UL	UL	6'0" / 183cm	2-pcs	2-10	2-6	50	245	8+Tip	A	108
NE-C-602ML	ML	6'0" / 183cm	2-pcs	7-15	6-12	50	245	8+Tip	A	115
NE-C-602M	M	6'0" / 183cm	2-pcs	7-28	8-17	50	270	8+Tip	A	118
NE-C-662M	M	6'6" / 198cm	2-pcs	7-28	8-17	50	290	8+Tip	A	124
NE-C-702MH	MH	7'0" / 213cm	2-pcs	10-35	10-20	50	290	9+Tip	A	141
Spinning										
NE-S-562L	L	5'6" / 168cm	2-pcs	5-10	4-10	50	205	6+Tip	B	102
NE-S-602UL	UL	6'0" / 183cm	2-pcs	2-10	2-6	50	245	6+Tip	B	103
NE-S-602ML	ML	6'0" / 183cm	2-pcs	7-15	6-12	50	245	6+Tip	B	107
NE-S-662M	M	6'6" / 198cm	2-pcs	7-28	8-17	50	290	7+Tip	B	121
NE-S-702MH	MH	7'0" / 213cm	2-pcs	10-35	10-20	50	290	7+Tip	B	137
Travel										
NE-C-604ML	ML	6'0" / 183cm	2-pcs	7-15	6-12	50	200	9+Tip	A	129

COMPETITION

- 24T carbon blank construction
- Stainless steel guide frames
- Durable titanium oxide guide inserts
- Stainless steel hooded reel seat with Okuma tooling logo
- Split grip butt design for reduced weight and improved balance
- Comfortable EVA fore and rear grips
- Stainless steel hook keeper



COMPETITION

Model	Rod Power	Length	Sections	Casting Wt. (g)	Foregrip length (mm)	Reargrip Length (mm)	Number of Guide	Handle Style	Weight (g)
Casting Rods									
CM-C-562L	L	5'6" / 168cm	2-pcs	2-8	35	250	7+Tip	B	90
CM-C-602UL	UL	6'0" / 183cm	2-pcs	2-8	35	275	8+Tip	B	95
CM-C-602ML	ML	6'0" / 183cm	2-pcs	5-17	35	275	8+Tip	B	102
CM-C-601M	M	6'0" / 183cm	1-pcs	8-25	35	275	8+Tip	B	106
CM-C-662ML	ML	6'6" / 198cm	2-pcs	7-18	35	275	9+Tip	B	110
CM-C-661M	M	6'6" / 198cm	1-pcs	10-30	35	275	9+Tip	B	115
CM-C-701M	M	7'0" / 213cm	1-pcs	10-30	35	275	9+Tip	B	126
CM-C-702M	M	7'0" / 213cm	2-pcs	10-30	35	275	9+Tip	B	129
Spinning Rods									
CM-S-562UL	UL	5'6" / 168cm	2-pcs	0-7	35	200	5+Tip	A	89
CM-S-562L	L	5'6" / 168cm	2-pcs	2-8	35	200	5+Tip	A	92
CM-S-562ML	ML	5'6" / 168cm	2-pcs	4-15	35	200	5+Tip	A	96
CM-S-602UL	UL	6'0" / 183cm	2-pcs	2-8	35	200	5+Tip	A	98
CM-S-602L	L	6'0" / 183cm	2-pcs	2-10	35	200	5+Tip	A	102
CM-S-602ML	ML	6'0" / 183cm	2-pcs	5-17	35	200	5+Tip	A	106
CM-S-601M	M	6'0" / 183cm	1-pcs	8-25	35	200	5+Tip	A	109
CM-S-602M	M	6'0" / 183cm	2-pcs	8-25	35	200	5+Tip	A	112
CM-S-662L	L	6'6" / 198cm	2-pcs	3-15	35	225	5+Tip	A	116
CM-S-662ML	ML	6'6" / 198cm	2-pcs	7-18	35	225	5+Tip	A	121
CM-S-661M	M	6'6" / 198cm	1-pcs	10-30	35	225	5+Tip	A	120
CM-S-662M	M	6'6" / 198cm	2-pcs	10-30	35	225	5+Tip	A	123
CM-S-662MH	MH	6'6" / 198cm	2-pcs	10-40	35	225	5+Tip	A	126
CM-S-702L	L	7'0" / 213cm	2-pcs	4-15	35	240	6+Tip	A	125
CM-S-702ML	ML	7'0" / 213cm	2-pcs	8-20	35	240	6+Tip	A	130
CM-S-701M	M	7'0" / 213cm	1-pcs	10-30	35	240	6+Tip	A	135
CM-S-702M	M	7'0" / 213cm	2-pcs	10-30	35	240	6+Tip	A	136
CM-S-702MH	MH	7'0" / 213cm	2-pcs	15-40	35	240	6+Tip	A	139
CM-S-702H	H	7'0" / 213cm	2-pcs	20-60	35	240	6+Tip	A	142
CM-S-762ML	ML	7'6" / 229cm	2-pcs	8-25	35	260	7+Tip	A	140
CM-S-762M	M	7'6" / 229cm	2-pcs	12-35	35	260	7+Tip	A	145
CM-S-762MH	MH	7'6" / 229cm	2-pcs	10-20	35	260	7+Tip	A	150
CM-S-802ML	ML	8'0" / 244cm	2-pcs	10-30	50	310	7+Tip	A	152
CM-S-802M	M	8'0" / 244cm	2-pcs	15-40	50	310	7+Tip	A	157
CM-S-802MH	MH	8'0" / 244cm	2-pcs	20-45	50	310	7+Tip	A	167
CM-S-802H	H	8'0" / 244cm	2-pcs	30-80	50	310	7+Tip	A	178
CM-S-902M	M	9'0" / 274cm	2-pcs	20-50	50	360	8+Tip	A	179
CM-S-902MH	MH	9'0" / 274cm	2-pcs	20-80	50	360	8+Tip	A	186
CM-S-902H	H	9'0" / 274cm	2-pcs	30-100	50	360	8+Tip	A	198
CM-S-1002MH	MH	10'0" / 305cm	2-pcs	20-80	50	400	8+Tip	A	212
CM-S-1002H	H	10'0" / 305cm	2-pcs	40-120	50	400	8+Tip	A	228

Fuel Spin

FUEL SPIN RODS FEATURE:

- 24T GT blank construction
- Fast action
- Complete range with 16 lengths and CW possible
- Motor sports design inspiration
- Pure energy for fishing
- 3 Split EVA handle to reduce the weight and good balance
- Stainless steel frame SIC guides
- Graphite cushions reel seat
- Designed to match Okuma Fuel Spin reels



FUEL SPIN

Model	Rod Power	Length (cm)	Sections	Casting Wt. (g)	Foregrip length (mm)	Reargrip Length (mm)	Number of Guide	Weight (g)
FSP-S-602L	L	183	2-pcs	2-10	35	220	5+Tip	99
FSP-S-602M	M	183	2-pcs	5-20	35	230	5+Tip	100
FSP-S-602H	H	183	2-pcs	15-40	35	250	5+Tip	114
FSP-S-662L	L	197	2-pcs	3-15	35	235	5+Tip	105
FSP-S-662ML	ML	197	2-pcs	7-22	35	245	5+Tip	107
FSP-S-662M	M	197	2-pcs	10-30	35	255	5+Tip	113
FSP-S-662H	H	197	2-pcs	20-50	35	265	5+Tip	126
NEW FSP-S-702UL	UL	213	2-pcs	0-8	35	265	6+Tip	103
FSP-S-702L	L	213	2-pcs	5-20	35	265	5+Tip	111
FSP-S-702M	M	213	2-pcs	10-30	35	270	6+Tip	125
FSP-S-702H	H	213	2-pcs	20-60	35	280	6+Tip	138
NEW FSP-S-762UL	UL	228	2-pcs	2-12	35	280	7+Tip	108
FSP-S-802L	L	243	2-pcs	5-25	35	295	7+Tip	140
FSP-S-802M	M	243	2-pcs	15-40	35	310	7+Tip	149
FSP-S-802H	H	243	2-pcs	30-80	35	340	7+Tip	173
FSP-S-902L	L	274	2-pcs	7-30	35	300	7+Tip	165
FSP-S-902M	M	274	2-pcs	20-50	35	310	7+Tip	179
FSP-S-902H	H	274	2-pcs	30-100	35	360	7+Tip	209



Wave Power

WAVE POWER RODS FEATURE:

- 24T GT blank construction
- Fast action
- Stainless steel frame SIC guides
- 3 Split EVA handle to reduce the weight and good balance
- Graphite cushions reel seat
- Telescopic version available
- Designed to match Okuma Aria spin reels



WAVE POWER

Model	Rod Power	Length (cm)	Sections	Casting Wt. (g)	Foregrip length (mm)	Reargrip Length (mm)	Number of Guide	Handle Style	Weight (g)
Spinning Rods									
WP-S-602L	L	183	2-pcs	2-10	35	220	5+Tip	B	100
WP-S-602M	M	183	2-pcs	5-20	35	230	5+Tip	B	102
WP-S-602H	H	183	2-pcs	15-40	35	250	5+Tip	B	112
WP-S-662L	L	197	2-pcs	3-15	35	245	5+Tip	B	104
WP-S-662M	M	197	2-pcs	10-30	35	255	5+Tip	B	108
WP-S-662H	H	197	2-pcs	20-50	35	265	5+Tip	B	120
NEW WP-S-662XH	XH	197	2-pcs	25-70	35	265	5+Tip	B	125
NEW WP-S-702UL	UL	213	2-pcs	0-8	35	240	6+Tip	B	103
WP-S-702L	L	213	2-pcs	4-15	35	240	6+Tip	B	112
WP-S-702M	M	213	2-pcs	10-30	35	270	6+Tip	B	120
WP-S-702H	H	213	2-pcs	20-60	35	280	6+Tip	B	132
NEW WP-S-702XH	XH	213	2-pcs	30-80	35	280	6+Tip	B	143
NEW WP-S-762UL	UL	228	2-pcs	2-12	35	280	7+Tip	B	108
WP-S-802L	L	244	2-pcs	5-25	35	295	7+Tip	B	136
WP-S-802M	M	244	2-pcs	15-40	35	310	7+Tip	B	147
WP-S-802H	H	244	2-pcs	30-80	35	310	7+Tip	B	170
WP-S-902L	L	274	2-pcs	7-30	35	300	7+Tip	B	163
WP-S-902M	M	274	2-pcs	20-50	35	310	7+Tip	B	173
WP-S-902H	H	274	2-pcs	30-100	35	310	7+Tip	B	201
NEW WP-S-1002M	M	305	2-pcs	25-60	35	360	9+Tip	B	203
Casting Rods									
NEW WP-C-601M	M	183	1-pc	8-25	35	220	8+Tip	A	103
NEW WP-C-601H	H	183	1-pc	15-45	35	220	8+Tip	A	108
NEW WP-C-661M	M	197	1-pc	10-30	35	275	8+Tip	A	109
NEW WP-C-661H	H	197	1-pc	20-50	35	275	8+Tip	A	117
NEW WP-C-661XH	XH	197	1-pc	25-70	35	275	8+Tip	A	123
NEW WP-C-662XH	XH	197	2-pcs	20-75	35	275	8+Tip	A	133
NEW WP-C-701H	H	213	1-pc	20-60	35	275	9+Tip	A	132
NEW WP-C-701XH	XH	213	2-pcs	20-60	35	275	9+Tip	A	142
NEW WP-C-702XH	XH	213	1-pc	30-80	35	275	9+Tip	A	137
Tele Spin									
WP-S-605M-T	M	183	5-pcs	5-20	35	235	4+Tip	B	101
WP-S-705M-T	M	213	5-pcs	10-30	35	250	4+Tip	B	108
WP-S-806M-T	M	244	6-pcs	15-40	35	265	5+Tip	B	143
WP-S-907M-T	M	274	7-pcs	20-50	35	300	5+Tip	B	192
WP-S-1007M-T	M	304	7-pcs	25-60	35	345	6+Tip	B	223
NEW WP-S-1107M-T	M	335	7-pcs	30-70	35	345	6+Tip	B	244
NEW WP-S-1208M-T	M	365	8-pcs	35-80	35	345	7+Tip	B	287



BALTIC STICK

BALTIC STICK RODS FEATURE:

- High modulus ultra-responsive carbon blank construction
- Double foot, stainless steel guide frames
- Zirconium guides inserts reduce friction
- Quality Okuma graphite reel seat
- EVA fore and rear grips for maximum durability
- Rubber end cap
- Supplied in quality rod bag



BALTIC STICK

Model	Rod Power	Length	Casting Wt. (g)	Sections	Foregrip length (mm)	Reargrip Length (mm)	Number of Guide	Weight (g)
BAL-S-802MH	MH	8'0" / 244cm	180	2-pcs	120	325	7+Tip	244
BAL-S-802H	H	8'0" / 244cm	100-250	2-pcs	120	325	7+Tip	263
BAL-S-902MH	MH	9'0" / 274cm	180	2-pcs	120	325	7+Tip	263
BAL-S-902H	H	9'0" / 274cm	100-250	2-pcs	120	325	7+Tip	296
BAL-S-1002MH	MH	10'0" / 305cm	180	2-pcs	120	370	7+Tip	310



TACTICAL

TACTICAL RODS FEATURE:

- High modulus ultra-sensitive and responsive carbon blank construction
- Fast tape with UFR TIP design
- Anti-tangle stainless steel guides frame
- Double footed guides with polished titanium oxide guide inserts
- Okuma tooling split trigger reel seat
- Hard EVA split handle design
- Quality cloth bag package



TACTICAL

Model	Rod Power	Length	Sections	Casting Wt. (oz)	Line Wt. (lbs)	Reargrip Length (mm)	Number of Guide	Handle Style	Weight (g)
TT-C-661M	M	6'6" / 198cm	1-pcs	1/8-5/8	8-14	240	9+Tip	A	105
TT-C-6101MH	MH	6'10" / 208cm	1-pcs	1/4-1	10-20	240	9+Tip	A	109
TT-C-702MH	MH	7'0" / 213cm	2-pcs	1/4-1 1/2	10-20	265	9+Tip	A	123
TT-C-701MH	MH	7'0" / 213cm	1-pcs	1/4-3/4	10-20	265	9+Tip	A	113
TT-C-701H	H	7'0" / 213cm	1-pcs	1/4-1/2	12-30	265	9+Tip	A	131
TT-C-741MH	MH	7'4" / 224cm	1-pcs	1/4-1 1/2	10-20	285	9+Tip	A	114
TT-C-741H	H	7'4" / 224cm	1-pcs	1/4-3/4	14-30	285	9+Tip	A	126
TT-S-562UL	UL	5'6" / 168cm	2-pcs	1/32-3/16	4-8		6+Tip	B	75
TT-S-701MH	MH	7'0" / 213cm	2-pcs	1/4-3/4	10-20	265	7+Tip	B	118
TT-S-702MH	MH	7'0" / 213cm	1-pcs	1/4-3/4	10-20	265	7+Tip	B	122

RED V1

RED V1 RODS FEATURE:

- High modulus ultra-sensitive and responsive carbon blank construction
- Fast tape blank special design for bass rods series
- Okuma tooling skeleton reel seat with cushioned stainless steel hood
- Durable Polymer and EVA split grip to reduce the weight and keep the balance
- Quality stainless steel guides frame
- Polished titanium oxide guide inserts
- Supplied with a quality rod bag



RED V1

Model	Rod Power	Length	Sections	Line Wt.(lbs)	Lure Wt.(oz)	Reargrip Length (mm)	Number of Guide	Handle Style	Weight (g)
Casting									
REV1-C-662MH	MH	6'6" / 198cm	2-pcs	10-18	3/16-5/8	275	8+Tip	B	128
REV1-C-702MH	MH	7'0" / 213cm	2-pcs	10-20	1/4-3/4	275	9+Tip	B	145
Spinning									
REV1-S-702MH	MH	7'0" / 213cm	2-pcs	10-20	1/4-3/4	260	7+Tip	A	139

RED V2 RODS FEATURE:

- High modulus ultra-sensitive and responsive carbon blank construction
- Fast tape blank special design for bass rods series
- Quality stainless steel guides frame
- Polished titanium oxide guide inserts
- Okuma tooling skeleton reel seat with cushioned stainless steel hood
- Camou EVA split grip and zero fore grip design to reduce the weight and keep the balance
- Supplied with a quality rod bag

RED V2



RED V2

Model	Rod Power	Length	Sections	Line Wt.(lbs)	Lure Wt.(oz)	Reargrip Length (mm)	Number of Guide	Handle Style	Weight (g)
Casting									
NEW REV2-C-662MH	MH	6'6" / 198cm	2-pcs	10-18	3/16-5/8	275	8+Tip	B	126
NEW REV2-C-702MH	MH	7'0" / 213cm	2-pcs	10-20	1/4-3/4	275	9+Tip	B	142
REV2-C-701MH	MH	7'0" / 213cm	1-pcs	10-20	1/4-3/4	275	9+Tip	B	134
Spinning									
NEW REV2-S-662MH	MH	6'6" / 198cm	2-pcs	10-18	3/16-5/8	260	6+Tip	A	120
REV2-S-702MH	MH	7'0" / 213cm	2-pcs	10-20	1/4-3/4	260	7+Tip	A	136



PSYCHO-PERCH SPIN

PSYCHO PERCH SPIN RODS FEATURE:

- Ultra-light high modulus carbon blank construction
- UFR: Ultimate Flex Reinforced rod tip technology
- New exclusive psychedelic blank artwork
- CCS Seaguide, 316 stainless steel frame SIC guide
- View blank screw down reel seat
- 3 split EVA handle with rubber cork inserts
- Covering all European styles of perch fishing
- High quality cloth bag



PSYCHO PERCH

Model	Rod Power	Length (cm)	Sections	Casting Wt. (g)	Foregrip length (mm)	Reargrip Length (mm)	Number of Guide	Handle Style	Weight (g)
UFR SPIN									
PSY-S-632UL	UL	190	2-pcs	1-8	25	235	7+Tip	A	78
PSY-S-632L	L	190	2-pcs	2-12	25	235	7+Tip	A	81
PSY-S-632ML	ML	190	2-pcs	3-18	25	235	7+Tip	A	84
PSY-S-732L	L	220	2-pcs	3-18	25	235	8+Tip	A	90
PSY-S-732ML	ML	220	2-pcs	4-24	25	235	8+Tip	A	96
PSY-S-732M	M	220	2-pcs	7-32	25	235	8+Tip	A	102
PSY-S-772UL	UL	230	2-pcs	1-8	25	235	9+Tip	A	93
PSY-S-772L	L	230	2-pcs	2-12	25	235	9+Tip	A	99
PSY-S-772ML	ML	230	2-pcs	3-18	25	235	9+Tip	A	105
PSY-S-892UL	UL	267	2-pcs	1-8	25	290	10+Tip	A	109
PSY-S-892L	L	267	2-pcs	2-12	25	290	10+Tip	A	112
PSY-S-892ML	ML	267	2-pcs	3-18	25	290	10+Tip	A	115
UFR CASTING									
PSY-C-732ML	ML	230	2-pcs	4-24	25	275	10+Tip	B	106
PSY-C-732M	M	230	2-pcs	7-32	25	275	10+Tip	B	115



G-Control

G-CONTROL RODS FEATURE:

- Ultra-light high modulus carbon blank construction
- UFR sensitive tip and crossed carbon thread improve lifting power and maximum strength
- All rods have been designed for specific trout fishing
- Seaguide XO anti-tangle 316-stainless steel guides
- Zirconium guides inserts reduce friction
- Light weight ergonomic touch blank reel seats
- Ergonomic shaped, hard EVA handles
- EVA split grip and EVA fore grip for reduced weight and feel
- High quality cloth bag package



G-CONTROL

	Model	Rod Power	Length	Sections	Casting Wt. (g)	Foregrip Length (mm)	Reargrip Length (mm)	Number of Guide	Weight (g)
NEW	GCT-S-612XUL	XUL	6'2" / 188cm	2-pcs	0.6-3	35	150	6+ Tip	73
	GCT-S-622UL	UL	6'2" / 188cm	2-pcs	0.6-3	35	175	7+Tip	78
	GCT-S-622L	L	6'2" / 188cm	2-pcs	1-4	35	175	7+Tip	80
	GCT-S-702L	L	7'0" / 213cm	2-pcs	1-8	35	225	8+Tip	86
	GCT-S-802L	L	8'0" / 244cm	2-pcs	1-8	35	245	9+Tip	97

LRF

LRF RODS FEATURE:

- OKUMA Patent UFR Technology on the Tip blank, increased rod's sensitive tip, lifting power and maximum strength
- Seaguide unique XO guides, SS316 frame and SIC inserts
- Line Flow Tapered Micro Guide system
- Deluxe Okuma gold label reel seat
- Spiral Carbon tape design on the Butt section, improved strength, durability, and highlighted the whole rod
- Split grip butt design for reduced weight and improved balance



LRF

	Model	Rod Power	Length	Sections	Casting Wt. (g)	Foregrip Length (mm)	Reargrip Length (mm)	Number of Guide	Handle Style	Weight (g)
	LRF-S-602L	L	6'0" / 183cm	2-pcs	1-7	35	235	7+Tip	A	78
	LRF-S-662L	L	6'6" / 198cm	2-pcs	2-8	35	235	7+Tip	A	80
	LRF-S-702L	L	7'0" / 213cm	2-pcs	2-8	35	235	8+Tip	A	92
	LRF-S-762L	L	7'6" / 229cm	2-pcs	3-9	35	235	8+Tip	A	95
	LRF-S-803L	L	8'0" / 244cm	3-pcs	2-12	35	305	9+Tip	A	99
Dropshop										
	LRF-S-802M	M	8'0" / 244cm	2-pcs	5-25	35	290	9+Tip	A	107
	LRF-S-702MH	MH	7'0" / 213cm	2-pcs	10-50	35	250	8+Tip	A	113
TELE SPIN										
	LRF-S-605UL-T	UL	6'0" / 208cm	5-Tele	1-7	35	215	4+Tip	B	90
	LRF-S-665UL-T	UL	6'6" / 198cm	5-Tele	1-8	35	215	4+Tip	B	96
	LRF-S-706UL-T	UL	7'0" / 213cm	6-Tele	1-8	35	215	5+Tip	B	99
	LRF-S-766UL-T	UL	7'6" / 229cm	6-Tele	1-9	35	215	5+Tip	B	103

Light Range Fishing

Okuma have patented the UFR technology – that truly gives an amazing performance on the light range fishing rods.

LIGHT RANGE FISHING RODS FEATURE:

- Light weight 24T carbon material
- Japanese EVA split handle construction
- Okuma quality reel seat
- CCS SIN shooting guides
- Okuma UFR tip strength
- Cloth bag included



LIGHT RANGE FISHING

Model	Rod Power	Length	Sections	Casting Wt. (g)	Foregrip length (mm)	Reargrip Length (mm)	Number of Guide	Weight (g)
LRF-S-612L-1	L	6'1" / 185cm	2-pcs	1-7	35	245	7+Tip	80
LRF-S-712ML-1	ML	7'1" / 216cm	2-pcs	3-12	35	245	8+Tip	98
LRF-S-812ML-1	ML	8'1" / 246cm	2-pcs	8-22	35	295	9+Tip	129
LRF-S-862M-1	M	8'6" / 259cm	2-pcs	12-32	35	295	9+Tip	146

RODSTER SPIN

RODSTER RODS FEATURE:

- Super strong composite & graphite blank construction
- UFR: Ultimate Flex Reinforced rod tip technology
- 15% lighter than Classic UFR rods
- Double leg SIC guides
- Full EVA handle with Rubber cork top ring
- Strong graphite reel seat with cushions and hoods
- ABS butt cap on spin models
- Soft ABS gimbal on boat models



RODSTER

Model	Rod Power	Length (cm)	Sections	Lure Wt. (g)	Foregrip length (mm)	Reargrip Length (mm)	Number of Guide	Handle Style	Weight (g)
Spinning									
RST-S-562L	L	167	2-pcs	5-15	55	175	5+Tip	A	118
RST-S-562M	M	167	2-pcs	10-30	55	175	5+Tip	A	123
RST-S-662L	L	197	2-pcs	7-15				A	154
RST-S-702L	L	213	2-pcs	4-15	70	225	5+Tip	A	166
RST-S-702M	M	213	2-pcs	10-30	70	225	5+Tip	A	181
RST-S-702H	H	213	2-pcs	20-60	70	225	5+Tip	A	212
RST-S-802L	L	244	2-pcs	5-20	80	285	5+Tip	A	197
RST-S-802M	M	244	2-pcs	10-30	80	285	5+Tip	A	225
RST-S-802H	H	244	2-pcs	20-60	80	285	5+Tip	A	256
RST-S-902MH	MH	274	2-pcs	20-60	80	405	5+Tip	A	288
RST-S-902H	H	275	2-pcs	40-80	80	405	5+Tip	A	306
RST-S-1002H	H	304	2-pcs	40-80	90	465	6+Tip	A	328
Boat									
RST-C-602M Boat	M	182	2-pcs	20-30lbs	120	405	6+Tip	B	246
RST-C-702M Boat	M	213	2-pcs	20-30lbs	140	425	6+Tip	B	301

Light Range Fishing TELE SPIN



LIGHT RANGE FISHING TELE SPIN

Model	Rod Power	Length	Sections	Casting Wt. (g)	Foregrip length (mm)	Reargrip Length (mm)	Number of Guide	Weight (g)
LRF-T-605UL-1	UL	6'0" / 183cm	5-Tele	1-7	35	215	4+Tip	94
LRF-T-706L-1	L	7'0" / 213cm	6-Tele	3-12	35	215	5+Tip	103
LRF-T-766ML-1	ML	7'6" / 229cm	6-Tele	8-22	35	215	5+Tip	113

EPIXOR

EPIXOR RODS FEATURE:

- 30+40T Hi Modulus carbon blank construction
- Alu butt screw cap
- Supplied in quality rods bag
- 30+40T Hi Modulus carbon blank construction
- Alu butt screw cap
- Supplied in quality rods bag



EPIXOR

	Model	Rod Power	Length (cm)	Sections	Section	Transport Length (cm)	Weight (g)
NEW	EPIXOR Bolo 4004	MH	400	4-pcs	4-pcs	131	108
NEW	EPIXOR Bolo 5005	MH	500	5-pcs	5-pcs	131	174
NEW	EPIXOR Bolo 6006	MH	600	6-pcs	6-pcs	131	238
NEW	EPIXOR Bolo 7007	MH	700	7-pcs	7-pcs	131	334

COMPETITION POLE

COMPETIRION POLE RODS FEATURE:

- Light weight carbon blank construction
- Durable components
- 6 different colors Purple, Yellow, Blue, Red, Green and Orange
- Supplied in quality rods bag

COMPETITION BOLO

	Model	Rod Power	Length (cm)	Sections	Transport Length (cm)	Weight (g)
NEW	Competition Pole 3003	MH	300	3-pcs	120	85
NEW	Competition Pole 4004	MH	400	4-pcs	120	157
NEW	Competition Pole 5005	MH	500	5-pcs	120	229
NEW	Competition Pole 6006	MH	600	6-pcs	120	332
NEW	Competition Pole 7007	MH	700	7-pcs	120	431
NEW	Competition Pole 8008	MH	800	8-pcs	120	578



G-POWER Tele Pole

G-POWER TELE POLE RODS FEATURE:

- Strong composite blank construction
- Durable components



G-POWER TELE POLE

	Model	Rod Power	Length (cm)	Sections	Transport Length (cm)	Weight (g)
NEW	G-Power Tele Pole 3003	M	300	3-pcs	115	115
NEW	G-Power Tele Pole 4004	M	400	4-pcs	115	200
NEW	G-Power Tele Pole 5005	M	500	5-pcs	115	331
NEW	G-Power Tele Pole 6006	M	600	6-pcs	115	466
NEW	G-Power Tele Pole 7007	M	700	7-pcs	115	618
NEW	G-Power Tele Pole 8008	M	800	8-pcs	115	775

G-POWER Travel Pole

G-POWER TRAVEL POLE RODS FEATURE:

- Light weight composite Travel telepole.
- Ultra short travel length.



G-POWER TRAVEL POLE

	Model	Rod Power	Length (cm)	Sections	Transport Length (cm)	Weight (g)
NEW	G-Power Travel Pole 1804	M	180	4-pcs	64	
NEW	G-Power Travel Pole 2104	M	210	4-pcs	64	
NEW	G-Power Travel Pole 2405	M	240	5-pcs	64	58
NEW	G-Power Travel Pole 2705	M	270	5-pcs	64	61
NEW	G-Power Travel Pole 3006	M	300	6-pcs	64	89
NEW	G-Power Travel Pole 3607	M	360	7-pcs	64	125
NEW	G-Power Travel Pole 3908	M	390	8-pcs	64	156
NEW	G-Power Travel Pole 4208	M	420	8-pcs	64	158
NEW	G-Power Travel Pole 4509	M	450	9-pcs	64	201
NEW	G-Power Travel Pole 5411	M	540	11-pcs	64	



MERIDIANA Bolo

- MERIDIANA RODS FEATURE:**
- Toray 46T Hi modulus carbon blank construction with Okuma UFR technology
 - UFR II: Ultimate Flex Reinforcement rod tip technology
 - Seaguide Saltwater resistant light guides for Tele Bolo
 - Fuji NS stainless steel plate reel seat
 - Protected in a quality guides cover



MERIDIANA BOLO

	Model	Rod Power	Length (cm)	Sections	Reargrip Length (cm)	Number of Guide	Transport Length (cm)	Weight (g)
NEW	MERIDIANA BOLO 6006	MH	600	6-pcs	420	8+Tip	148	618
NEW	MERIDIANA BOLO 7007	MH	700	7-pcs	420	9+Tip	148	775

HELIOS Bolo

- HELIOS BOLO RODS FEATURE:**
- 40T Toray carbon material, slim, light and powerful blank construction
 - Fuji Saltwater resistant guides with Alconite inserts
 - Protected in a quality guide cover
 - Fuji NS stainless steel plate reel seat
 - Supplied in a quality rod bag



HELIOS BOLO

	Model	Rod Power	Length (cm)	Sections	Casting Wt.(g)	Reargrip Length (mm)	Number of Guide	Transport Length(cm)	Weight (g)
NEW	HELIOS Bolo 4004	MH	400	4-pcs	10-30	420	6+Tip	137	182
NEW	HELIOS Bolo 5005	MH	500	5-pcs	10-30	420	7+Tip	137	234
NEW	HELIOS Bolo 6006	MH	600	6-pcs	10-30	420	8+Tip	137	297
NEW	HELIOS Bolo 7007	MH	700	7-pcs	10-30	420	9+Tip	137	396



EPIXOR Bolo

- EPIXOR BOLO RODS FEATURE:**
- 36-Ton Hi Modulus carbon blank construction
 - Seaguide Saltwater resistant light guides for Tele Bolo
 - Protected in a quality guide cover
 - Fuji NS stainless steel plate reel seat
 - Supplied in a quality rod bag



EPIXOR BOLO

	Model	Rod Power	Length (cm)	Sections	Reargrip Length (mm)	Number of Guide	Transport Length (cm)	Weight (g)
NEW	EPIXOR Bolo 4004	MH	400	4-pcs	420	6+Tip	140	145
NEW	EPIXOR Bolo 5005	MH	500	5-pcs	420	7+Tip	140	209
NEW	EPIXOR Bolo 6006	MH	600	6-pcs	420	8+Tip	140	275
NEW	EPIXOR Bolo 7007	MH	700	7-pcs	420	9+Tip	140	381



COMPETITION Bolo

- COMPETITION BOLO RODS FEATURE:**
- Durable 24+30T carbon blank construction
 - Quality stainless steel light guides for Tele Bolo
 - Protected in a quality guide cover
 - Quality stainless steel plate reel seat
 - Supplied in a quality rod bag



COMPETITION BOLO

	Model	Rod Power	Length (cm)	Sections	Reargrip Length (mm)	Number of Guide	Transport Length (cm)	Weight (g)
NEW	COMPETITION Bolo 4004	MH	400	4-Tele	450	5+Tip	124	186
NEW	COMPETITION Bolo 5005	MH	500	5-Tele	450	6+Tip	126	268
NEW	COMPETITION Bolo 6006	MH	600	6-Tele	450	7+Tip	127	387
NEW	COMPETITION Bolo 7007	MH	700	7-Tele	450	8+Tip	128	499



TOMCAT

TOMCAT RODS FEATURE:

- Responsive and durable 24T carbon blank construction
- Heavy duty matt gunsmoke SIC guides
- CCS Seaguide for Vertical item
- Strong graphite reel seat with cushions
- Rubber round butt cap
- 4 series covering all type of carfish disciplines
- Supplied in quality cloth bag



TOMCAT

Model	Rod Power	Length	Sections	Lure Wt. (g)	Foregrip length (mm)	Reargrip Length (mm)	Number of Guide	Weight (g)
SPIN								
TMC-S-702MH	MH	7'0" / 213cm	2-pcs	60-160	120	380	6+Tip	300
TMC-S-802MH	MH	8'0" / 244cm	2-pcs	60-160	120	410	6+Tip	350
NEW TMC-S-902M	M	9'0" / 274cm	2-pcs	40-120	120	460	6+Tip	362
TMC-S-902MH	MH	9'0" / 274cm	2-pcs	60-160	120	460	6+Tip	394
X-STRONG								
TMC-S-802XH	XH	8'0" / 244cm	2-pcs	200-300	135	465	5+Tip	388
NEW TMC-S-902H	H	9'0" / 274cm	2-pcs	150-280	135	485	6+Tip	401
TMC-S-902XH	XH	9'0" / 274cm	2-pcs	200-300	135	485	6+Tip	445
TMC-S-992XH	XH	9'9" / 297cm	2-pcs	200-300	135	485	7+Tip	528
EXPERT								
TMC-S-1062H	H	10'6" / 320cm	2-pcs	100-250	200	465	7+Tip	198
VERTICAL								
TMC-S-602MH	MH	6'0" / 183cm	2-pcs	150	130	390	6+Tip	264



LS-8K Carp

LS-8K CARP RODS FEATURE:

- Toray 40T high modulus carbon, slim, light and powerful blank construction
- Gunsmoke Deep-drawn frame guides with SIC inserts
- Fuji TVS and DNPS reel seat
- Okuma carbon line clip
- Slim cone EVA with durable shrink tube butt handle
- Engraved aluminum butt cap
- New Semi tele version carp rods are available
- High quality cloth bag



LS-8K CARP

Model	Rod Power	Length	Sections	Line Wt. (lbs)	Reargrip Length (mm)	Number of Guide	Handle style	Transport Length (cm)	Weight (g)
NEW LS8K-CA-802M	M	8'0" / 244cm	2-pcs	2.50	390	5+Tip	A	125	141
NEW LS8K-CA-1002M	M	10'0" / 305cm	2-pcs	2.75	410	5+Tip	A	155	193
NEW LS8K-CA-1002MH	MH	10'0" / 305cm	2-pcs	3.00	410	5+Tip	A	155	221
NEW LS8K-CA-1002H	H	10'0" / 305cm	2-pcs	3.25	410	5+Tip	A	156	231
NEW LS8K-CA-1202M	M	12'0" / 366cm	2-pcs	2.75	495	5+Tip	A	186	256
NEW LS8K-CA-1202MH	MH	12'0" / 366cm	2-pcs	3.00	495	5+Tip	A	186	275
NEW LS8K-CA-1202H	H	12'0" / 366cm	2-pcs	3.25	520	5+Tip	A	186	301
NEW LS8K-CA-1202XH	XH	12'0" / 366cm	2-pcs	3.50	520	5+Tip	A	186	330
NEW LS8K-CA-1202XXH	XXH	12'0" / 366cm	2-pcs	4.00	520	5+Tip	A	186	338
NEW LS8K-CA-1302XH	XH	13'0" / 396cm	2-pcs	3.50	545	5+Tip	A	202	365
NEW LS8K-CA-1302XXH	XXH	13'0" / 396cm	2-pcs	4.00	545	5+Tip	A	202	389
Semi Tele									
NEW LS8K-CA-1003M-T	M	10'0" / 305cm	3-pcs	2.75	410	5+Tip	B	125	221
NEW LS8K-CA-1003MH-T	MH	10'0" / 305cm	3-pcs	3.00	410	5+Tip	B	125	237
NEW LS8K-CA-1003H-T	H	10'0" / 305cm	3-pcs	3.25	410	5+Tip	B	125	252
NEW LS8K-CA-1003XH-T	XH	10'0" / 305cm	3-pcs	3.50	435	5+Tip	C	125	277
NEW LS8K-CA-1203M-T	M	12'0" / 366cm	3-pcs	2.75	495	5+Tip	B	152	276
NEW LS8K-CA-1203MH-T	MH	12'0" / 366cm	3-pcs	3.00	495	5+Tip	B	152	300
NEW LS8K-CA-1203H-T	H	12'0" / 366cm	3-pcs	3.25	520	5+Tip	B	150	330
NEW LS8K-CA-1203XH-T	XH	12'0" / 366cm	3-pcs	3.50	540	5+Tip	C	150	350

8K Carp

8K CARP RODS FEATURE:

- 40T Toray carbon material, slim, light and powerful blank construction
- Black stainless steel frame guides with SIC inserts
- Fuji DPS pate reel seat
- Okuma carbon line clip
- Slim and Ergonomic shape EVA with durable shrink tube butt handle
- Engraved aluminum butt cap
- High quality cloth bag



8K CARP

Model	Rod Power	Length	Sections	Line Wt. (lbs)	Foregrip length (mm)	Reargrip Length (mm)	Number of Guide	Weight (g)
8K-CA-1002MH	MH	10'0" / 305cm	2-pcs	3.0	20	560	5+Tip	213
8K-CA-1202MH	MH	12'0" / 366cm	2-pcs	3.0	20	560	5+Tip	252
8K-CA-1202H	H	12'0" / 366cm	2-pcs	3.5	20	560	5+Tip	290
8K-CA-1302H	H	13'0" / 396cm	2-pcs	3.5	20	560	5+Tip	319

LS-6K Carp

LS-6K CARP RODS FEATURE:

- Slim and light weight 30T carbon Blank
- Exclusive Okuma BOPP blank covering
- Okuma DPS reel seat
- Okuma carbon line clip
- Ergonomic shape EVA with durable shrink tube butt handle
- Engraved aluminum butt cap
- High quality cloth bag



LS-6K CARP

Model	Rod Power	Length	Sections	Line Wt. (lbs)	Foregrip length (mm)	Reargrip Length (mm)	Number of Guide	Weight (g)
LS-CA-1002MH	MH	10'0" / 305cm	2-pcs	3.0	20	560	5+Tip	261
LS-CA-1202MH	MH	12'0" / 366cm	2-pcs	3.0	20	560	5+Tip	296
LS-CA-1202H	H	12'0" / 366cm	2-pcs	3.5	20	560	5+Tip	341
LS-CA-1302H	H	13'0" / 396cm	2-pcs	3.5	20	590	5+Tip	378
NEW LS--CA-1303H	H	13'0" / 396cm	3-pcs	3.5	20	590	5+Tip	385
NEW LS-CA-1202XXH	XXH	12'0" / 366cm	2-pcs	5.0	20	560	5+Tip	396



Custom Black carp

CUSTOM BLACK CARP RODS FEATURE:

- Slim and light weight 24T carbon blank
- SIC Guides
- Heavy Duty Okuma graphite reel seat
- Ergonomic shaped EVA with durable shrink tube handle
- Supplied in a quality rod bag



CUSTOM BLACK CARP

Model	Rod Power	Length	Sections	Line Wt. (lbs)	Foregrip length (mm)	Reargrip Length (mm)	Number of Guide	Weight (g)
CB-CA-1202MH	MH	12'0" / 366cm	2-pcs	3.0	20	560	5+Tip	334
CB-CA-1202H	H	12'0" / 366cm	2-pcs	1.6	20	560	5+Tip	370
CB-CA-1203H	H	12'0" / 366cm	3-pcs	1.6	20	560	5+Tip	367
CB-CA-1302H	H	13'0" / 396cm	2-pcs	1.6	20	590	5+Tip	423
CB-CA-1303H	H	13'0" / 396cm	3-pcs	1.6	20	590	5+Tip	388
CB-CA-1202XXH	XXH	12'0" / 366cm	2-pcs	2.3	20	590	5+Tip	391
NEW CB-CA-1302XXH	XXH	13'0" / 396cm	2-pcs		20	590	5+Tip	430



C-FIGHT Carp

C-FIGHT CARP RODS FEATURE:

- Light weight 24T carbon blank
- Exclusive camouflage blank covering
- Minimalistic artwork matching UK codes
- Semi matt frame SIC guides
- Starting guide 50mm on 12'0"
- Slim EVA butt handle
- Engraved aluminum butt cap
- Graphite reel sat with cushions
- Telescopic version available



C-FIGHT CARP

	Model	Rod Power	Length	Sections	Line Wt. (lbs)	Foregrip length	Reargrip Length (mm)	Number of Guide	Weight (g)
	CF-CA-802M	M	8'0" / 244cm	2-pcs	2.50	N/A	380	5+Tip	168
	CF-CA-902M	M	9'0" / 274cm	2-pcs	2.75	N/A	450	5+Tip	208
	CF-CA-1002MH	MH	10'0" / 305cm	2-pcs	3.00	N/A	500	5+Tip	273
NEW	CF-CA-1202MH	MH	12'0" / 366cm	2-pcs	3.00	N/A	550	5+Tip	327
	CF-CA-1202H	H	12'0" / 366cm	2-pcs	3.25	N/A	550	5+Tip	354
NEW	CF-CA-1202XH	XH	12'0" / 366cm	3-pcs	3.50	N/A	550	5+Tip	378
MEW	CF-CA-1203XH	XH	12'0" / 366cm	3-pcs	3.50	N/A	550	5+Tip	350
NEW	CF-CA-1302XH	XH	13'0" / 396cm	2-pcs	3.50	N/A	550	6+Tip	408
NEW	CF-CA-1202XXH	XXH	12'0" / 366cm	2-pcs	4.5	N/A	550	5+Tip	382
	CF-CA-1206H-T	H	12'0" / 366cm	6-Tele	3.25	N/A	570	5+Tip	295
NEW	CF-CA-1206XH-T	XH	12'0" / 366cm	6-Tele	3.50	N/A	570	5+Tip	312
NEW	CF-CA-1306XH-T	XH	13'0" / 396cm	6-Tele	3.50	N/A	570	5+Tip	334



AVENGER Carp

AVENGER CARP RODS FEATURE:

- Light weight carbon blanks
- Quality stainless steel guides
- Heavy Duty Okuma graphite reel seat
- Supplied in rod bag



AVENGER CARP

	Model	Rod Power	Length	Sections	Line Wt. (lbs)	Foregrip length (mm)	Reargrip Length (mm)	Number of Guide	Weight (g)
	AV-CA-1002MH	MH	10'0" / 305cm	2-pcs	3.0	20	500	5+Tip	268
	AV-CA-1202MH	MH	12'0" / 366cm	2-pcs	3.0	20	560	5+Tip	324
	AV-CA-1202H	H	12'0" / 366cm	2-pcs	3.5	20	560	5+Tip	344
	AV-CA-1203H	H	12'0" / 366cm	3-pcs	3.5	20	560	5+Tip	367
	AV-CA-1302H	H	13'0" / 396cm	2-pcs	3.5	20	560	6+Tip	420
NEW	AV-CA-1206MH-T	MH	12'0" / 366cm	6+Tele	3.5	20	560	5+Tip	305
	AV-CA-1206H-T	H	12'0" / 366cm	6-Tele	3.5	20	560	5+Tip	319

LONGBOW Carp

LONGBOW CARP RODS FEATURE:

- Durable carbon blanks construction
- Quality stainless steel minima guides
- Okuma DPS pipe reel seat

LONGBOW CARP

	Model	Rod Power	Length	Sections	Line Wt. (lbs)	Foregrip length (mm)	Reargrip Length (mm)	Number of Guide	Weight (g)
NEW	LB-CA-1202H	H	12'0" / 366cm	2-pcs	3.5	20	560	5+Tip	365
NEW	LB-CA-1302H	H	13'0" / 396cm	2-pcs	3.5	20	560	5+Tip	388

ALTERA

ALTERA TELE CAST RODS FEATURE:

- Light weight 24T carbon blank
- Matt gunsmoke frame SIC guides
- Okuma graphite reel seat
- Slim EVA butt handle
- Aluminum screw end cap with non-skid rubber
- Supplied in quality cloth bag

ALTERA TELE CAST

	Model	Rod Power	Length	Sections	Lure Wt. (g)	Foregrip length	Reargrip Length (mm)	Number of Guide	Weight (g)
	ALT-S-1206MH-T	MH	12'0" / 366cm	6-Tele	40-80	N/A	510	5+Tip	278
	ALT-S-1206H-T	H	12'0" / 366cm	6-Tele	50-100	N/A	510	5+Tip	296
	ALT-S-1306H-T	H	13'0" / 396cm	6-Tele	60-120	N/A	540	5+Tip	364

8K

8K FEEDER RODS FEATURE:

- Ultra light 40T carbon blank construction
- Faster action with 2 different power tips
- Black frame SIC guides
- Fuji DPS plate reel seat
- AAA cork quality full handle
- High quality rods bags

8K FEEDER

	Model	Rod Power	Length	Sections	Casting Wt. (g)	Foregrip length (mm)	Reargrip Length (mm)	Number of Guide	Weight (g)
NEW	8K-F-1002M	M	10'0" / 305cm	2-pcs	30	65	430	12+Tip	130
NEW	8K-F-1102M	M	11'0" / 335cm	2-pcs	45	65	430	12+Tip	139
NEW	8K-F-1203M	M	12'0" / 366cm	3-pcs	20-60	65	450	13+Tip	186
NEW	8K-F-1203MH	MH	12'0" / 366cm	3-pcs	40-80	65	450	13+Tip	192
	8K-F-1203H	H	12'0" / 366cm	3-pcs	60-120	65	450	13+Tip	202
NEW	8K-F-1303MH	MH	13'0" / 396cm	3-pcs	40-80	65	450	14+Tip	206
	8K-F-1303H	H	13'0" / 396cm	3-pcs	60-120	65	450	14+Tip	208
NEW	8K-F-1403XH	XH	14'0" / 427cm	3-pcs	150	65	470	15+Tip	264



LS-6K

LS-6K FEEDER RODS FEATURE:

- Slim and light weight 30T carbon blanks
- Faster action with 2 different power tips
- Exclusive Okuma BOPP blank covering
- Gun-smoke SIC guides
- Okuma DPS reel seat
- Quality cork quality full handle
- Supplied in quality rods bags



LS-6K FEEDER

	Model	Rod Power	Length	Sections	Lure Wt. (g)	Foregrip length (mm)	Reargrip Length (mm)	Number of Guide	Weight (g)
NEW	6K-F-1002M	M	10'0" / 305cm	2-pcs	30	65	430	12+Tip	163
NEW	6K-F-1102M	M	11'0" / 335cm	2-pcs	45	65	430	12+Tip	175
NEW	6K-F-1203M	M	12'0" / 366cm	3-pcs	20-60	65	450	13+Tip	191
	6K-F-1203MH	MH	12'0" / 366cm	3-pcs	40-80	65	450	13+Tip	204
	6K-F-1203H	H	12'0" / 366cm	3-pcs	60-120	65	450	13+Tip	216
NEW	6K-F-1303MH	MH	13'0" / 396cm	3-pcs	40-80	65	450	14+Tip	219
	6K-F-1303H	H	13'0" / 396cm	3-pcs	60-120	65	450	14+Tip	235
	6K-F-1203XH	XH	12'0" / 366cm	3-pcs	> 150	65	450	13+Tip	252
	6K-F-1303XH	XH	13'0" / 396cm	3-pcs	> 150	65	470	14+Tip	261
	6K-F-1403XH	XH	14'0" / 427cm	3-pcs	> 150	65	470	15+Tip	305
NEW	6K-F-1203XXH	XXH	12'0" / 366cm	3-pcs	> 180	65	450	13+Tip	275
NEW	6K-F-1303XXH	XXH	13'0" / 396cm	3-pcs	> 180	65	470	14+Tip	292



Custom Black Feeder

CUSTOM BLACK FEEDER RODS FEATURE:

- Slim and light weight 30T carbon blanks
- Fast action with 3 different power tips
- Unique use of Bopp Blank protect film
- Quality stainless steel guides
- Okuma graphite reel seat
- Supplied in quality rod bag



CUSTOM BLACK FEEDER

	Model	Rod Power	Length	Sections	Lure Wt. (g)	Foregrip length (mm)	Reargrip Length (mm)	Number of Guide	Weight (g)
	CB-F-1003MH	MH	10'0" / 305cm	3-pcs	> 80	65	450	12+Tip	172
	CB-F-1203MH	MH	12'0" / 366cm	3-pcs	40-80	65	450	13+Tip	219
	CB-F-1203H	H	12'0" / 366cm	3-pcs	60-120	65	450	13+Tip	248
	CB-F-1303MH	MH	13'0" / 396cm	3-pcs	40-80	65	450	14+Tip	249
	CB-F-1303H	H	13'0" / 396cm	3-pcs	60-120	65	450	14+Tip	294
	CB-F-1103MH	MH	11'0" / 335cm	3-pcs	>60	65	430	12+Tip	197
	CB-F-1203MH	MH	12'0" / 366cm	3-pcs	> 60	65	450	13+Tip	213
NEW	CB-F-1203XH	XH	12'0" / 366cm	3-pcs	> 150	65	450	13+Tip	245
	CB-F-1303XH	XH	13'0" / 396cm	3-pcs	> 150	65	470	14+Tip	299
	CB-F-1403XH	XH	14'0" / 427cm	3-pcs	> 150	65	490	15+Tip	327

Ceymar

CEYMAR FEEDER FEATURE:

- Slim and balance carbon blank construction
- Progressive action
- Supplied with 3 solid tips in tube
- Quality stainless steel frame guides
- Polished Titanium Oxide guide inserts
- Okuma DPS reel seat
- Quality cork and EVA handles
- Supplied in quality rods bag

CEYMAR FEEDER

Model	Rod Power	Length (cm)	Sections	Lure Wt. (g)	Foregrip length (mm)	Reargrip Length (mm)	Number of Guide	Weight (g)
Feeder								
NEW C-F-1003MH	MH	300	3-pcs	40-80	65	450	12+Tip	202
C-F-1203MH	MH	360	3-pcs	40-80	65	450	13+Tip	261
C-F-1203H	H	360	3-pcs	60-120	65	450	13+Tip	282
C-F-1303MH	MH	390	3-pcs	40-80	65	450	14+Tip	295
C-F-1303H	H	390	3-pcs	60-120	65	450	14+Tip	334
Method Feeder								
C-F-1103MH-1	MH	330	3-pcs	>60g	65	430	12+Tip	232
C-F-1203MH-1	MH	360	3-pcs	>60g	65	450	13+Tip	254
River Feeder								
C-F-1303XH-1	XH	390	3-pcs	>150g	65	450	14+Tip	369
C-F-1403XH-1	XH	420	3-pcs	>150g	65	470	15+Tip	386

OKUMA FEEDER SOLID TIPS FEATURE:

- Okuma Standard Feeder solid tips
- They are workable for all Okuma feeder rods, like Ceymar feeder/Custom feeder/LS-6k/8K feeder rods
- Solid Glass 1oz/2oz/3oz and Solid carbon 3oz/4oz/5oz are available
- You can choose anyone for your feeder rods, or as the spare parts

OKUMA FEEDER SOLID TIP

Model	Rod Power
NEW Feeder Solid Tip LG	Feeder Solid Glass Tip LG 1oz Green
NEW Feeder Solid Tip MLG	Feeder Solid Glass Tip MLG 2oz White
NEW Feeder Solid Tip MG	Feeder Glass Solid Tip MG 3oz Yellow
NEW Feeder Solid Tip MC	Feeder Carbon Solid Tip MC 3oz Yellow
NEW Feeder Solid Tip MHC	Feeder Carbon Solid Tip MHC 4oz Orange
NEW Feeder Solid Tip HC	Feeder Carbon Solid Tip HC 5oz Red
NEW Feeder Tip PVC tube	Feeder Solid Tip PVC tube



Custom Black

CUSTOM BLACK MATCH FEATURE:

- 30T+40T Hi modulus carbon, slim, light weight and balanced blanks
- Okuma Unique Bopp blank protect film
- Quality stainless steel frame guides
- Polished Titanium Oxide guide inserts
- Okuma DPS pipe reel seat
- Quality cork and EVA handles
- Supplied in quality rods bag

CUSTOM BLACK MATCH

Model	Rod Power	Length	Sections	Lure Wt. (g)	Foregrip length (mm)	Reargrip Length (mm)	Number of Guide	Weight (g)
NEW CB-MA-1303M	M	13'0" / 396cm	3-pcs	5-25	65	430	12+Tip	204
NEW CB-MA-1303MH	MH	13'0" / 396cm	3-pcs	10-35	65	430	12+Tip	216
NEW CB-MA-1403M	M	14'0" / 427cm	3-pcs	5-25	65	430	13+Tip	224

Ceymar

CEYMAR MATCH / FEEDER RODS FEATURE:

- Light weight and balance carbon blank construction
- Progressive action
- Quality stainless steel frame guides
- Polished Titanium Oxide guide inserts
- Okuma DPS pipe reel seat
- Quality cork and EVA handles
- Supplied in quality rods bag

CEYMAR MATCH

Model	Rod Power	Length (cm)	Sections	Lure Wt. (g)	Foregrip length (mm)	Reargrip Length (mm)	Number of Guide	Weight (g)
C-M-1303M	M	390	3-pcs	5-25	65	430	12+Tip	237
NEW C-M-1403MH	MH	390	3-pcs	10-35	65	430	12+Tip	239
C-M-1403M	M	420	3-pcs	5-25	65	430	13+Tip	257

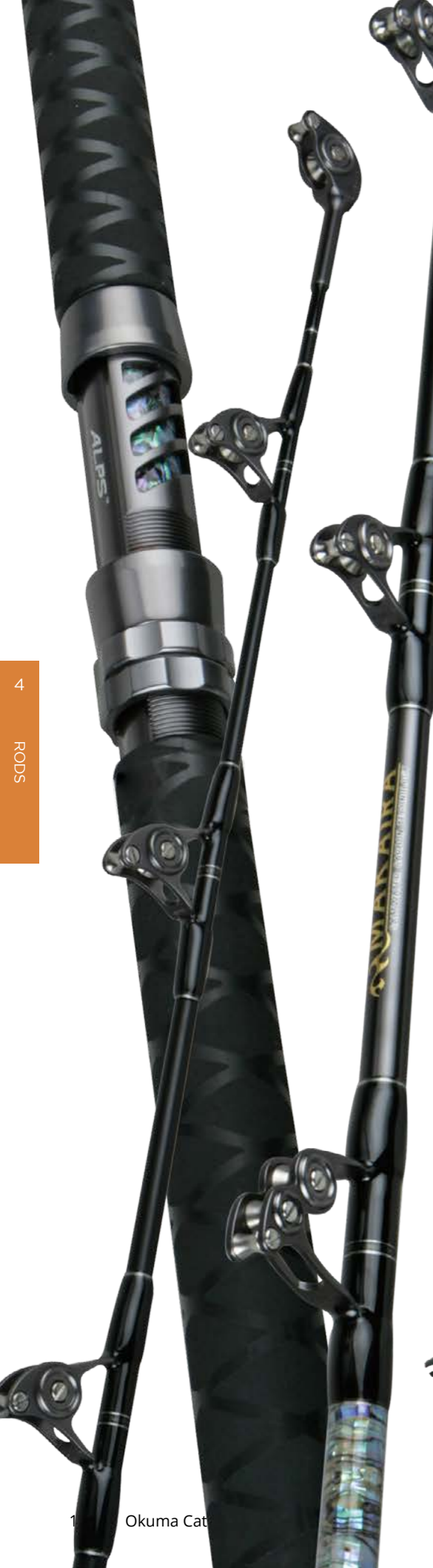

MAKAIRA

SALTWATER CARBON TECHNOLOGY

MAKAIRA RODS FEATURE:

- Carbon composite rod blank technology
- ALPS deep press 316 stainless guide frames
- Hard Zirconium guide inserts for compatibility with braided lines
- Custom ALPS aluminum reel seats with Abalone under lay
- IGFA tournament rods with full straight or bent aluminum rod butts
- Shrink tube grips for ultimate durability
- ALPS roller guides on trolling rods with large knot clearance
- Aluminum gimbals on trolling and popping rods
- Integrated rubber butt cap/gimbal design on all casting and spinning rods
- Custom abalone decoration above fore grip
- Custom leather wrapped fore grip on IGFA Stand Up rods



NEW ALPS RX PREMIUM ROLLER GUIDES

- * Tournament IGFA series rods feature black and gold RX roller guides
- * All Roller Trolling rods feature gunsmoke RX roller guides

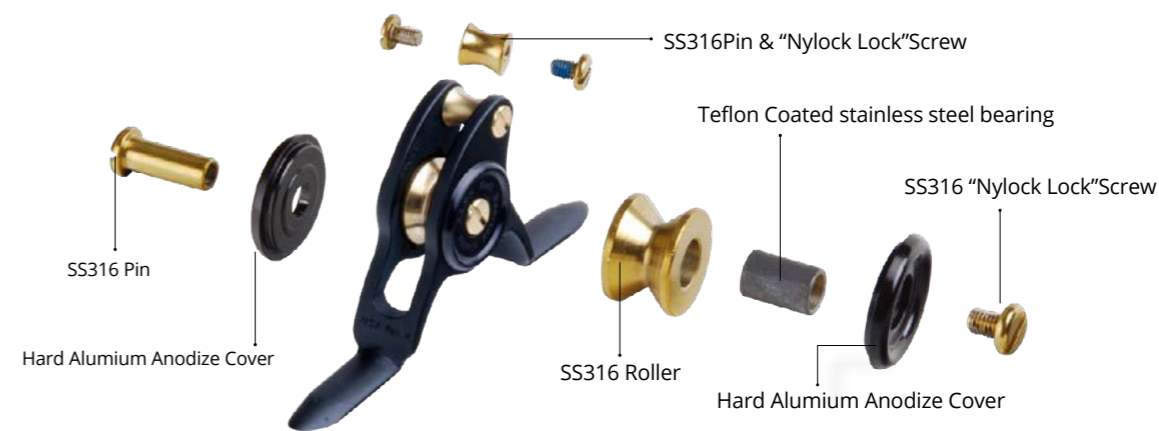

MAKAIRA SALTWATER RODS

Model	Rod Power	Rod Taper	Rod Length (cm)	Line Weight (lbs)	Lure Weight	Sections	Foregrip length (mm)	Reargrip length (mm)	Number of Guides	Handle Style	Weight (g)
Makaira IGFA Straight butt Stand-up Rods											
MAK-TR-581-30S	H	M/MF	173	30	N/A	1-pcs	330	300	4 + Tip	C	1012
MAK-TR-581-50S	XH	M/MF	173	50	N/A	1-pcs	330	300	4 + Tip	C	1055
MAK-TR-5101-80S	XXXH	M/MF	128	80	N/A	1-pcs	330	360	4 + Tip	C	1165
Makaira IGFA Bent butt Stand-up Rods											
MAK-TR-5101-50B	XH	M/MF	173	50	N/A	1-pcs	330	380	4 + Tip	D	1311
MAK-TR-5101-80B	XXH	M/MF	178	80	N/A	2-pcs	330	380	4 + Tip	D	1342
NEW MAK-TR-5101-120B	XXH	M/MF	178	120	120 lbs	2-pcs	330	380	4 + Tip	D	1440

PCH Custom

PCH CUSTOMROLLING RODS FEATURE:

- Durable 24-ton carbon and E-Glass constructed rod blanks
- 3K-woven carbon outer blank wrap improves hoop strength
- ALPS RX series roller guides with 316 stainless steel rollers
- Proprietary curved or straight woven carbon fiber butt sections
- Detachable butt section with machined aluminum reel seats
- Tapered shrink tube foregrips offer maximum durability



A Shrink tube foregrip with straight carbon butt and aluminum reel seat



B Shrink tube foregrip with bent carbon butt and aluminum reel seat

PCH CUSTOM

	Model	Rod Power	Length	Sections	Line Wt. (lbs)	Foregrip length (mm)	Reargrip Length (mm)	Number of Guide	Handle style	Weight (g)
NEW	PCH-TRS-561M	MH	5'6" / 168cm	1-pcs	40-100	330	330	4+Tip	A	754
NEW	PCH-TRS-561MH	MH	5'6" / 168cm	1-pcs	60-130	330	330	4+Tip	A	771
NEW	PCH-TRS-5101H	H	5'1" / 155cm	1-pcs	80-150	279	355	4+Tip	A	970
NEW	PCH-TRS-5101XH	XH	5'1" / 155cm	1-pcs	100-250	279	355	4+Tip	A	1026
NEW	PCH-TRS-661M	M	6'6" / 198cm	1-pcs	40-100	330	330	5+Tip	A	839
NEW	PCH-TRS-661MH	MH	6'6" / 198cm	1-pcs	60-130	330	355	5+Tip	A	853
NEW	PCH-TRS-6101H	H	6'1" / 185cm	1-pcs	80-150	279	393.7	5+Tip	A	1014
NEW	PCH-TRS-6101XH	XH	6'1" / 185cm	1-pcs	100-250	279	393.7	5+Tip	A	1134
NEW	PCH-TRB-5101H	H	5'1" / 155cm	1-pcs	80-150	279	355	5+Tip	B	833
NEW	PCH-TRB-5101XH	XH	5'1" / 155cm	1-pcs	100-250	279	355	5+Tip	B	899
NEW	PCH-TRB-6101H	H	6'1" / 185cm	1-pcs	80-150	279	393.7	5+Tip	B	907
NEW	PCH-TRB-6101XH	XH	6'1" / 185cm	1-pcs	100-250	279	393.7	5+Tip	B	1006

OKUMA WOVEN CARBON BUTT FEATURE:

- 220g lighter for the Bent one
- 150g lighter for the straight one
- Strength 30kg broken the Alu reel seat, but the carbon is no problem
- 2# straight/bent and 4# straight/bent are available
- Changeable with ALPS Alu butt
- MOQ 5pcs for our Okuma friends
- Supplied in quality bag

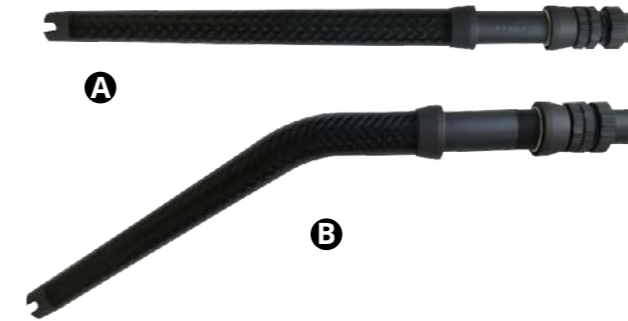

OKUMA CARBON BUTT

	Model	Transport Length (cm)	Connection ID (mm)	Weight (g)
NEW	Carbon Straight Butt #2	465	24.8	316
NEW	Carbon Straight Butt #4	585	28.8	466
NEW	Carbon Bent Butt #2	510	24.8	383
NEW	Carbon Bent Butt #4	570	28.8	448

SLX

SLX TROLLING RODS FEATURE:

- Responsive and durable 24-ton carbon blank construction
- Split handle ferrule connection, for natural bending and easy transportation
- Anti-tangle stainless steel guides frames
- Zirconium guides inserts reduce friction from braided lines
- Machined aluminum reel seat with extra locking nut



SLX

	Model	Rod Power	Length	Sections	Line Wt. (lbs)	Foregrip length (mm)	Reargrip Length (mm)	Number of Guide	Weight (g)
	SLX-C-682ML	ML	6'8" / 203cm	1+1	4-6	220	375	7+TIP	283
	SLX-C-682M	M	6'8" / 203cm	1+1	8-12	220	375	7+TIP	295
	SLX-C-682MH	MH	6'8" / 203cm	1+1	16-20	220	375	7+TIP	320



SLY

SLY RODS FEATURE:

- Durable E-glass blank construction
- Fuji K-concept tangle free guides with Alconite inserts
- Special spiral guides design for all trolling and tuna rods
- ALPS Aluminum reel seat with large knot clearance
- Alps Aluminum gimbal



SLY

Model	Rod Power	Length (cm)	Sections	Line Wt. (lbs)	Foregrip length (mm)	Reargrip Length (mm)	Number of Guide	Weight (g)
Trollong								
SLY-C-661ML	ML	195	1+1	6-8	270	300	9+Tip	442
SLY-C-621M	M	185	1+1	12-20	270	300	8+Tip	458
Tuna								
SLY-C-621MH	MH	185	1+1	20-30	270	300	8+Tip	534
SLY-C-621H	H	185	1+1	30-50	270	300	8+Tip	562



CORTEZ

CORTEZ BOAT RODS FEATURE:

A super series of rods for modern sea fishing with both lures and Rigs/bait. Strong put-in 1/3 handle section and progressive, relatively tipped 2/3 blank section, with perfectly balanced action to play big fish like Cod, coalfish, halibut and big turbot.

- Light weight, high modulus carbon fiber blanks
- Stainless steel highrise guide frames with SIC rings
- Deluxe Okuma silver label reel seats
- Hard, durable EVA handle
- Okuma rubber gimbal for sea fishing
- High quality cloth bag package
- 3-sec rods supplied in deluxe travel bag



CORTEZ BOAT

Model	Rod Power	Length (cm)	Sections	Ling Weight (lbs)	Foregrip length (mm)	Reargrip Length (mm)	Number of Guide	Weight (g)
Casting								
CZ-C-662M	M	198	2-pcs	20-30	200	30	8+Tip	287
CZ-C-662MH	MH	223	2-pcs	30-50	200	30	8+Tip	298
CZ-C-742L	L	223	2-pcs	6-12	200	300	9+Tip	293
CZ-C-742ML	ML	223	2-pcs	12-20	200	300	9+Tip	298
CZ-C-742M	M	223	2-pcs	20-30	200	300	9+Tip	302
CZ-C-742MH	MH	223	2-pcs	30-50	200	300	9+Tip	306
Travel Cast								
CZ-C-663M	M	198	3-pcs	20-30	230	340	8+Tip	309
CZ-C-663MH	MH	198	3-pcs	30-50	230	340	8+Tip	320



Cold Water

COLD WATER RODS FEATURE:

- Responsive and durable 24-ton carbon blank construction
- Okuma Stronger DPS reel seat
- EVA fore grips and Durable shrink tube rear grips
- Okuma rubber gimbal on all models
- High quality guide lines special for inline rods



A Pipe reel seat with EVA fore and rear grips and rubber gimbal

COLD WATER INLINE BOAT

Model	Rod Power	Length (cm)	Sections	Line Weight (lbs)	Foregrip length (mm)	Reargrip Length (mm)	Number of Guide	Handle Style	Weight (g)
CW-C-742M	M	220	1+1	30	290	315	1+Tip	A	325
CW-C-742MH	MH	220	1+1	50	290	315	1+Tip	A	332
CW-C-742H	H	220	1+1	70	290	315	1+Tip	A	347



AZORES V2

AZORES V2 BLUE RODS FEATURE:

- Korean Quality high modulus carbon material
- Split handle ferrule connection design on popping rods
- ALPS deep press 316 stainless steel frames
- Zirconium guides inserts reduce friction from braided lines
- Hard, durable EVA handles
- Integrated rubber butt cap/gimbal
- 2-tone anodized metal parts
- Better quality cloth bag package



AZORES V2 POPPING

Model	Rod Power	Length	Sections	Line Wt.	Casting Wt. (g)	Foregrip length (mm)	Reargrip Length (mm)	Number of Guide	Weight (g)
Popping									
AZ-S-792MH	MH	7'9" / 236cm	1+1	PE 4-6	45-150	180	425	6+Tip	366
AZ-S-792H	H	7'9" / 236cm	1+1	PE 6-8	60-190	180	425	6+Tip	443
AZ-S-793MH	MH	7'9" / 236cm	3-pcs	PE 4-6	45-150	180	385	6+Tip	378



HAWAIIAN CUSTOM POPPING RODS FEATURES:

- Light and responsive 24/30-Ton, low resin carbon rod blanks
- 70/30 rod blank design, 2-pcs construction butted in foregrip
- Premium Fuji reel seat for maximum reliability
- Fuji K-concept double foot guide frames, help reduce tangles
- Fuji Alconite guide inserts for abrasion resistance
- Oversized guide sizing allows for improved knot clearance while casting
- 2-pcs blank aides in transportation, but offers max power, based on ferrule location
- Tapered TPE foregrip with TPE rear split grips for reduced weight and balance



A TPE/Compressed cork rear split grip with Fuji pipe reel seat

HAWAIIAN CUSTOM POPPING

Model	Rod Power	Length	Sections	Line Wt. (lbs)	Lure Wt. (g)	Foregrip length (mm)	Reargrip Length (mm)	Number of Guide	Handle Style	Weight (g)
HWP-S-832Ma	M	8'3" / 251cm	1+1	30-60	30-160	140	490	6+Tip	A	378
HWP-S-832MHa	MH	8'3" / 251cm	1+1	50-100	90-200	165	520	6+Tip	A	396



METALLOID S

The metalloids rods are made to handle the toughest saltwater fishing, only using the best materials and components available. These rods will cast the big lures and poppers, and fight the torpedoes of the ocean.

METALLOID S POPPIG RODS FEATURE:

- KOREAN Quality carbon material
- OC-9 carbon outer wrap to improve blank strength
- Deep press tangle free frame SIC guides
- Fuji black reel seat with LO/AN double lock
- Hard black EVA handles with slim dark grey design
- Extended front handle for fight gripping
- Pac bay graphite gimbal
- Fast dry mesh rod bag



METALLOIDS POPPING

Model	Rod Power	Length	Sections	Line Wt. (lbs)	Lure Wt. (g)	Foregrip length (mm)	Reargrip Length (mm)	Number of Guide	Weight (g)
MTL-S-762Ma	M	7'6" / 229cm	1+1	30-65	30-160	165	455	6+Tip	320
MTL-S-792Ma	M	7'9" / 236cm	1+1	50	50-150	195	455	6+Tip	343
MTL-S-792MHa	MH	7'9" / 236cm	1+1	80	80-200	195	455	6+Tip	361

METALOID

METALOID JIGGING RODS FEATURE:

- Extremely light weight and responsive 24T carbon rods blanks
- Okuma special blanks design to improve hoop strength
- Crossed carbon design to highlight METALOID jiggling and reinforce the whole rod
- ALPS deep press 316 stainless steel guides frame for saltwater fishing
- Zirconium guides inserts reduce friction from braided lines
- Fuji reel seat on casting and spinning models
- 2-ton anodized metal parts
- Fast dry mesh rod bag
- 4 new modes with new cosmetic



METALOID JIGGING

Model	Rod Power	Length	Sections	Line Wt.	Casting Wt. (g)	Foregrip length (mm)	Reargrip Length (mm)	Number of Guide	Handle Style	Weight (g)
Spinning Rod										
MTL-S-531L	L	5'3" / 160cm	1-pcs	PE 1.5-4	100-200	150	410	5+Tip	A	220
MTL-S-501M	M	5'0" / 152cm	1-pcs	PE 3-6	200-350	150	410	5+Tip	A	287
Casting Rod										
MTL-C-531L	L	5'3" / 160cm	1-pcs	PE 1.5-4	100-200	150	410	6+Tip	B	237
MTL-C-501M	M	5'0" / 152cm	1-pcs	PE 3-6	200-350	150	410	6+Tip	B	298
M-C-531ML	ML	5'3" / 160cm	1-pcs	PE 2-4	< 200	150	410	6+Tip	C	291
M-C-531M	M	5'3" / 160cm	1-pcs	PE 3-5	< 300	150	410	6+Tip	C	313
M-C-521MH	MH	5'2" / 157cm	1-pcs	PE 4-6	< 400	150	410	6+Tip	C	326



TESORO

TESORO JIGGING RODS FEATURE:

- Extremely light weight and responsive 24T carbon rod blanks
- UFR: Ultimate Flex Reinforcement technology increases
- ALPS high-rise 316 stainless steel frame SIC guides
- ALPS Aluminum anodized gimbal with rubber cover
- Fuji heavy duty reel seat with LO/AN double lock
- Special camou BOPP blank covering
- High quality rods bag



TESORO JIGGING

Model	Rod Power	Length	Sections	Line Wt.	Lure Wt.(g)	Foregrip length (mm)	Reargrip Length (mm)	Number of Guide	Handle Style	Weight (g)
Casting Rods										
NEW TSR-C-511ML	ML	5'1" / 155cm	1-pc	PE1-3	100-200	150	400	6+Tip	A	264
TSR-C-511M	M	5'1" / 155cm	1-pc	PE3-5	250-350	150	400	6+Tip	A	273
NEW TSR-C-501MH	MH	5'0" / 152cm	1-pc	PE3.5-5	300-400	150	400	6+Tip	A	275
TSR-C-501H	H	5'0" / 152cm	1-pc	PE4-6	350-500	150	400	6+Tip	A	278
TSR-C-491XH	XH	4'9" / 145cm	1-pc	PE5-8	>500	150	400	6+Tip	A	282
Spinning Rods										
NEW TSR-S-511ML	ML	5'1" / 155cm	1-pc	PE-1-3	100-200	150	390	6+Tip	B	254
TSR-S-511M	M	5'1" / 155cm	1-pc	PE3-5	250-350	150	390	5+Tip	B	263
NEW TSR-S-501MH	MH	5'0" / 152cm	1-pc	PE3.5-5	300-400	150	390	6+Tip	B	265
TSR-S-501H	H	5'0" / 152cm	1-pc	PE4-6	350-500	150	390	5+Tip	B	268
TSR-S-491XH	XH	4'9" / 145cm	1-pc	PE5-8	>500	150	390	5+Tip	B	276





METALOID

METALOID SLOW JIGGING RODS FEATURE:

- Slim high modulus carbon blank, with power carbon wrap
- Handle Ferrule connection allows for natural bend of the rod and 1-pc feeling
- Ergonomic shaped, Hard EVA handles
- Strong trigger and pipe Fuji reel seat for casting and spinning models
- Split handle design for reduced weight and add comfort
- Guides from Fuji KWAG Alconite, anti-tangle and saltwater resistant
- Delivered in quality cloth bag



METALOID SLOW JIGGING

Model	Rod Power	Length	Sections	Casting Wt. (g)	Foregrip length	Reargrip Length (mm)	Number of Guide	Handle Style	Weight (g)
Casting Rods									
MTL-C-682M	M	6'8" / 203cm	1+1	20-90	N/A	405	9+Tip	A	161
MTL-C-682MH	MH	6'8" / 203cm	1+1	60-140	N/A	405	9+Tip	A	159
Spining Rods									
MTL-S-682M	M	6'8" / 203cm	1+1	20-90	N/A	405	6+Tip	B	148
MTL-S-682MH	MH	6'8" / 203cm	1+1	60-140	N/A	405	6+Tip	B	172



TESORO SLOW JIGGING

TESORO SLOW JIGGING RODS FEATURE:

- Extremely light weight and responsive 24T carbon rod blanks
- Special camou BOPP blank covering
- 1-pc and 1+1 blank design for perfect bending action
- Fuji K-concept tangle free frame Alconite guides
- Fuji DPS and TCS reel seat
- High quality rods bag



TESORO SLOW JIGGING

Model	Rod Power	Length	Sections	Lure Wt. (g)	Foregrip length (mm)	Reargrip Length (mm)	Number of Guide	Handle Style	Weight (g)
Spinning Rods									
TSR-S-661ML	ML	6'6" / 198cm	1-PCS	20-90	35	410	7+Tip	A	137
TSR-S-661M	M	6'6" / 198cm	1-PCS	40-150	35	410	7+Tip	A	146
TSR-S-661MH	MH	6'6" / 198cm	1-PCS	60-200	35	410	7+Tip	A	157
TSR-S-661H	H	6'6" / 198cm	1-PCS	80-240	35	410	7+Tip	A	167
TSR-S-662M	M	6'6" / 198cm	1+1	40-150	35	410	7+Tip	A	147
TSR-S-662MH	MH	6'6" / 198cm	1+1	60-200	35	410	7+Tip	A	159
Casting Rods									
TSR-C-661ML	ML	6'6" / 198cm	1+1	20-90	35	410	9+Tip	B	135
TSR-C-661M	M	6'6" / 198cm	1-PCS	40-150	35	410	9+Tip	B	146
TSR-C-661MH	MH	6'6" / 198cm	1-PCS	60-200	35	410	9+Tip	B	156
TSR-C-661H	H	6'6" / 198cm	1-PCS	80-240	35	410	9+Tip	B	166
TSR-C-662M	M	6'6" / 198cm	1+1	40-150	35	410	9+Tip	B	148
TSR-C-662MH	MH	6'6" / 198cm	1+1	60-200	35	410	9+Tip	B	158



MAGDA AIR

MAGDA AIR RODS FEATURE:

- Slim high modulus carbon blank, with crossed carbon wrap reinforcement
- Okuma patent UFR TIP technology design on Light jig rods
- All 1-pcs design for perfect bending action
- Fuji K-concept tangle free guides with Alconite inserts
- Spiral guides design for all slow jig rods
- Ergonomic shaped, hard EVA handles
- Fuji reel seat
- High quality cloth bag package



MAGDA AIR

Model	Rod Power	Length	Sections	Line Weight	Casting Wt. (g)	Foregrip length (mm)	Reargrip Length (mm)	Number of Guide	Handle	Weight (g)
Slow Jig										
MA-C-661ML	ML	6'6" / 198cm	1-pcs	PE 1	120	N/A	410	9+TIP	B	138
MA-C-661M	M	6'6" / 198cm	1-pcs	PE 2	160	N/A	410	9+TIP	B	151
MA-C-661MH	MH	6'6" / 198cm	1-pcs	PE 3	220	N/A	410	9+TIP	B	163
MA-C-661H	H	6'6" / 198cm	1-pcs	PE 4	300	N/A	410	9+TIP	B	173
Tai Rubber										
NEW MA-C-682H	H	6'8" / 198cm	1+1	PE0.8-1.5	30-170	N/A	430	12+Tip	D	159
Light Jig										
MA-LJS601M	M	6'0" / 183cm	1-pcs	PE 1-3	90-150	115	350	7+TIP	A	127
MA-LJC601M	M	6'0" / 183cm	1-pcs	PE 1-3	90-150	25	375	8+TIP	C	125



4 RODS

4 RODS



AZORES SLOW JIGGING RODS FEATURE:

- Slim high modulus carbon blank, with power carbon wrap
- Split handle ferrule connection, for natural bending and easy transportation
- Guides from Fuji KWAG Alconite, anti-tangle and saltwater resistant
- Fuji stronger reel seat for sea fishing
- Ergonomic shaped, hard EVA handles
- Integrated rubber butt cap/gimbal
- Delivered in Quality cloth bag



AZORES SLOW JIGGING

Model	Rod Power	Length (cm)	Sections	Casting Wt. (g)	Reargrip Length (mm)	Number of Guide	Weight (g)
Slow Jigging							
AZ-S-682M	M	203	1+1	20-90	405	6+TIP	162
AZ-S-682MH	MH	203	1+1	60-140	405	6+TIP	187
AZ-S-702MH	MH	213	1+1	60-140	355	6+TIP	194

KOMODO[®]

KOMODO LIGHT JIGGING RODS FEATURE:

- Slim high modulus carbon blank, with crossed carbon wrap reinforcement
- Okuma patent UFR TIP technology design on Light jig rods
- All 1-pcs design for perfect bending action
- Fuji K-concept tangle free guides with Alconite inserts
- Spiral guides design for all slow jig rods
- Fuji reel seat
- Ergonomic shaped, hard EVA handles
- High quality cloth bag package



KOMODO LIGHT JIGGING

Model	Rod Power	Length	Sections	Line Weight	Casting Wt. (g)	Foregrip length (mm)	Reargrip Length (mm)	Number of Guide	Weight (g)
Light Jig									
KD-S-601UL	UL	6'0" / 183cm	1-pcs	PE0.6-1	40-80	110	345	7+Tip	
KD-S-601L	L	6'0" / 183cm	1-pcs	PE0.8-1.5	50-100	110	345	7+Tip	
KD-S-601ML	ML	6'0" / 183cm	1-pcs	PE1-2	60-120	110	345	7+Tip	
KD-S-601M	M	6'0" / 183cm	1-pcs	PE1.5-3	70-150	110	345	7+Tip	
KD-S-601MH	MH	6'0" / 183cm	1-pcs	PE2-4	90-180	110	345	7+Tip	

EGI SNIPER

EGI SNIPER RODS FEATURE:

- Toray 46T carbon blank, light weight, sensitive and balanced
- Fuji Titanium K-guides with SIC inserts
- Fuji IPS reel seat with the light EVA for handling good feeling
- Ergonomic split EVA grips design special for the good balance
- 1K woven spigot joint and aligned spots special for the EGI SNIPER
- Supplier in a high quality rod bag

EGI SNIPER

Model	Rod Power	Length (cm)	Sections	Line Weight	Casting Wt. (g)	Foregrip length (mm)	Reargrip Length (mm)	Number of Guide	Weight (g)
NEW EGS-S-862M	M	259	2-pcs	PE0.6-1.2	Egi 2.5-4	115	220	8+Tip	99



ARIA Egi

ARIA EGI RODS FEATURE:

- 40T Toray ultra-light carbon blank construction
- Fuji KR stainless steel frame guides
- Fuji Alconite inserts reduce friction
- Fuji VSS reel seat, Fuji slidable hook keeper
- Ergonomic shaped, split EVA handle design for reduced weight and feel
- Durable rubber cork end cap for good balance
- High quality cloth bag package

ARIA EGI

Model	Rod Power	Length (cm)	Sections	Line Weight	Casting Wt. (g)	Foregrip length (mm)	Reargrip Length (mm)	Number of Guide	Weight (g)
ARA-842M	M	250	2-PCS	PE0.6-1.2	Egi2.0-4.0	950	265	8+Tip	111



EPIXOR Egi

EPIXOR EGI RODS FEATURE:

- 40+46T Toray ultra-light carbon blank construction
- Fuji K-concept tangle free stainless steel guides
- Fuji Alconite inserts reduce friction
- Fuji VSS reel seat
- Ergonomic shaped, split EVA handle design to reduce weight
- Durable rubber cork end cap for good balance
- High quality cloth bag package



EPIXOR EGI

Model	Rod Power	Length (cm)	Sections	Line Weight	Casting Wt. (g)	Foregrip length (mm)	Reargrip Length (mm)	Number of Guide	Weight (g)
NEW EPI-S-762M	M	228	2-pcs	PE0.6-1.2	Egi 2.5-4	100	250	8+Tip	89
NEW EPI-S-832M	M	251	2-pcs	PE0.6-1.2	Egi 2.5-4	100	250	8+Tip	100

Egi Pro *Superlative Carbon Competition*

The Egi pro are designed to handle the light lures and delicate handling of squids and other light range species.

EGIPRO RODS FEATURE:

- Extremely light weight blank under 30T quality carbon construction
- Fuji micro guide set up and SIC top
- Japanese split handle construction
- Hard EVA + rubber cork handles
- Quality reel seat
- Supplied in quality rod bag



EGIPRO

Model	Rod Power	Length (cm)	Sections	Casting Weight	Line Weight	Foregrip length (mm)	Reargrip Length (mm)	Number of Guide	Weight (g)
EGI-S-822M	M	245	2 pcs	Egi 2.0-3.5	PE 0.8-1.5	115	245	7+TIP	120

FLX TIP

FLX TIP RODS FEATURE:

- Low resin and responsive 24T+30T carbon rod blanks
- Okuma patent UFR technology blank
- UFR: Ultimate Flex Reinforcement rod tip technology
- X-wrap carbon reinforcement on the Butt section
- CCS Seaguide, 316 stainless steel tangle free frame SIC guides
- TVS touch blank pipe reel seat
- Ergonomic shaped, split EVA handle design to reduce weight
- Supplied in quality rods bag



FLX TIP

Model	Rod Power	Length	Sections	Line Weight	Lure Weight	Foregrip length (mm)	Reargrip Length (mm)	Number of Guide	Weight (g)
FLX-S-762M	M	7'6" / 229cm	2-pcs	PE0.6-1.2	Egi 2.5-4	40	260	8+Tip	109
FLX-S-832M	M	8'3" / 251cm	2-pcs	PE0.6-1.5	Egi 2.5-4	40	280	8+Tip	126

ALTERA Egi TELE

ALTREA EGI RODS FEATURE:

- 24T carbon with Okuma UFR technology blank construction
- UFRII: Ultimate Flex Reinforcement rod tip technology
- Fuji quality guides
- TVS touched rod blank pipe reel seat
- Ergonomic shaped, split EVA handle design to reduce weight
- Supplied in quality rods bag



ALTERA EGI

Model	Rod Power	Length (cm)	Sections	Lure Weight (g)	Foregrip length (mm)	Reargrip Length (mm)	Number of Guide	Weight (g)
NEW ALT-S-806ML-T	ML	244	6-Tele	Egi 1.8-3.5 10-30	33mm	260mm	7+Tip	121

ALTERA Egi

ALTREA EGI RODS FEATURE:

- 24T carbon with Okuma UFR technology blank construction
- UFRII: Ultimate Flex Reinforcement rod tip technology
- Fuji quality guides
- TVS touched rod blank pipe reel seat
- Ergonomic shaped, split EVA handle design to reduce weight
- Supplied in quality rods bag



ALTERA EGI

Model	Rod Power	Length (cm)	Sections	Lure Weight (g)	Foregrip length (mm)	Reargrip Length (mm)	Number of Guide	Weight (g)
NEW ALT-S-822M	M	249	2-pcs	Egi 2.5-4 12-28	33	260	8+Tip	126

TATAKY Pro

TATAKY PRO RODS FEATURE:

- 24T ultra-light carbon blank construction with Okuma UFR technology
- UFR: Ultimate Flex Reinforcement rod tip technology
- Visual white tip design
- Fuji Micro guides
- Quality VSS pipe reel seat
- Split EVA handle design to reduce the weight
- Supplied in quality rod bag



TATAKY PRO

Model	Rod Power	Length (cm)	Sections	Lure Weight (g)	Foregrip length (mm)	Reargrip Length (mm)	Number of Guide	Weight (g)
NEW TTP-S-662MH	MH	198	2-pcs	150-200	30	440	11+Tip	117

Cold Water

Designed for jigging sabiki rigs when gathering bait, with the design allowing the rig to be wound inside the rod to minimise snagging and tangling when not in use, the Okuma Sabiki UTG rod has been designed from the ground up to overcome the shortcomings of other sabiki rods that have been pointed out to us by frustrated anglers.

COLD WATER RODS FEATURE:

- Durable and light weight 24T Carbon with Okuma UFR technology blanks construction.
- UFRII: Ultimate Flex Reinforcement rod tip technology.
- Reduces tangles and simplifies sabiki storage
- Improved design features
- Two piece design with butt join
- Additional length to suit more sabiki jig brands
- Okuma DPS pipe reel seat and eva grips



COLD WATER

Model	Rod Power	Length	Sections	Line Weight (lbs)	Foregrip length (mm)	Reargrip Length (mm)	Number of Guide	Weight (g)
NEW CW-C-732SBK	MH	7'3" / 221cm	1+1	10-20	120	275	N/A	238

CEDROS Surf

CEDROS SURF RODS FEATURE:

- Toray 40T high modulus carbon blank construction
- COMPETITION SENSOR TIP, solid carbon inserted hybrid tip
- Fuji K-concept guides with Alconite insert and SIC top
- Fuji DPS screw-lock reel seat with cushioned hood
- Ergonomic butt grip
- High quality rods bag



CEDROS SURF

Model	Rod Power	Length (cm)	Sections	Lure Weight (g)	Foregrip length	Reargrip Length (mm)	Number of Guide	Weight (g)
NEW CJ-S-1403H	H	420	3-pcs	100-200	N/A	700	7+Tip	473
NEW CJ-S-1503H	H	450	3-pcs	100-200	N/A	700	7+Tip	499

AZORES XP

AZORES XP RODS FEATURE:

- Toray 40T high modulus carbon blank construction
- Fuji K-concept guides with Alconite insert
- Fuji DPS screw-lock reel seat with cushioned hood
- Anti slip handle design
- High quality rods bag



AZORES XP SURF

Model	Rod Power	Length (cm)	Sections	Lure Weight (g)	Foregrip length	Reargrip Length (mm)	Number of Guide	Weight (g)
NEW ZXP-S-1403H	H	420	3-pcs	100-200g	N/A	700mm	7+Tip	443
NEW ZXP-S-1503H	H	450	3-pcs	100-200g	N/A	700mm	7+Tip	468

AZORES II

AZORES II RODS FEATURE:

- AZORE SURF upgraded version, lighter and better balance
- 40T high modulus Toray carbon blank construction
- OC-9 carbon outer wrap and solid carbon tip
- Fuji or Local deep press resistant guide frames
- Fuji DPS pipe reel seat
- Anti slip handle design
- High quality rods bag



AZORES II

Model	Rod Power	Length (cm)	Sections	Lure Wt. (g)	Reargrip Length (mm)	Number of Guide	Weight (g)
AZII-S-1403H	H	420	3-pcs	100-200	670	5+Tip	368
AZII-S-1403XH	XH	420	3-pcs	120-250	670	5+Tip	398
AZII-S-1503H	H	450	3-pcs	100-200	670	5+Tip	393
AZII-S-1503XH	XH	450	3-pcs	120-250	670	5+Tip	433

MASTER Surf

MASTER SURF RODS FEATURE:

- 30T Japanese carbon material and faster action blank construction
- Seaguide deep-press guide frames with SIC inserts
- ALPS Deluxe Reel seat
- Shrink wrap Non slip handle
- High quality handbag package



MASTER SURF

Model	Rod Power	Length (cm)	Sections	Casting Wt. (g)	Foregrip length	Reargrip Length (mm)	Number of Guide	Weight (g)
MST-S-1503M	M	450	3-pcs	120	N/A	690	7+TIP	462
MST-S-1503MH	MH	450	3-pcs	160	N/A	690	7+TIP	546
MST-S-1503H	H	450	3-pcs	200	N/A	690	7+TIP	617

TRIO- REX ARENA

TRIO-REX ARENA RODS FEATURE:

- 30T Korean carbon blank with HYBRID TIP
- Saltwater resistant deep press guides
- Okuma Branded quality reel seat
- Anti-slip handle design
- Supplied in a quality rod bag



TRIO-REX ARENA BEACH

Model	Rod Power	Length (cm)	Sections	Casting Wt. (g)	Foregrip length	Reargrip Length (mm)	Number of Guide	Weight (g)
TXA-S-1403M	M	420	3-pcs	60-100	N/A	685	7+TIP	415
TXA-S-1503M	M	450	3-pcs	60-100	N/A	685	7+TIP	454

TRIO- REX SURF

The trio res surf rods are built on fast and strong Korean high quality carbon materials, using saltwater resistant components to ensure maximum performance.

TRIO-REX SURF RODS FEATURE:

- 30T Korean Carbon material construction
- Saltwater resistant High rise guides
- Okuma Branded quality reel seat
- Anti slip handle
- Easy grip connection construction
- Supplied in a quality rod bag



TRIO-REX SURF

Model	Rod Power	Length (cm)	Sections	Lure Wt. (g)	Foregrip length	Reargrip Length (mm)	Number of Guide	Weight (g)
TX-S-1002H	H	300	2-pcs	100-200	N/A	550	5+Tip	281
TX-S-1103H	H	330	3-pcs	100-200	N/A	580	5+Tip	314
TX-S-1203H	H	360	3-pcs	100-200	N/A	600	5+Tip	360
TX-S-1303H	H	390	3-pcs	100-200	N/A	600	5+Tip	412
TX-S-1403H	H	420	3-pcs	100-200	N/A	600	5+Tip	469
TX-S-1403XH	XH	420	3-pcs	120-250	N/A	660	5+Tip	555
TX-S-1503H	H	450	3-pcs	100-200	N/A	660	6+Tip	502
TX-S-1503XH	XH	450	3-pcs	120-250	N/A	660	6+Tip	581

DISTANCE SURF ARENA

DISTANCE SURF ARENA RODS FEATURE:

- Light weight and responsive HM carbon construction
- UFR: Ultimate Flex Reinforcement rod tip technology
- Visual Orange tip section
- Lowrider SIC guides
- Anti-slip grip for easy put in/take off
- Okuma graphite cushion reel seat
- ALPS rubber end cap for anti-slip
- Delivered in cloth bag



DISTANCE SURF ARENA

Model	Rod Power	Length (cm)	Sections	Lure Wt. (g)	Foregrip length	Reargrip Length (mm)	Number of Guide	Weight (g)
DSA-S-1403H	H	420	3-pcs	100-200	N/A	660	5+Tip	461
DSA-S-1403XH	XH	420	3-pcs	120-250	N/A	660	6+Tip	478
DSA-S-1503H	H	450	3-pcs	100-200	N/A	660	5+Tip	481
DSA-S-1503XH	XH	450	3-pcs	120-250	N/A	660	6+Tip	538

NEMESIS SURF

NEMESIS SURF RODS FEATURE:

- Ultra-responsive 24-carbon blank construction
- Quality stainless steel frame guides with saltwater treatment
- Strong graphite reel seats
- Anti-slip grip for easy put in/take off
- Alu screw end cap with Rubber cushion for anti-slip



NEMESIS SURF

Model	Rod Power	Length (cm)	Sections	Casting Wt. (g)	Foregrip length	Reargrip Length (mm)	Number of Guide	Weight (g)
NE-S-1403MH	MH	426	3-pcs	150-300	N/A	670	5+Tip	528
NE-S-1503MH	MH	457	3-pcs	150-300	N/A	710	6+Tip	596
NE-S-1603MH	MH	487	3-pcs	150-300	N/A	710	6+Tip	683

SURFLINER SURF

SURFLINER SURF RODS FEATURE:

- Light weight and responsive HM carbon construction
- Quality stainless steel guides
- Anti-slip grip for easy put in / take off
- Okuma graphite cushion reel seat
- ALPS rubber end cap for anti-slip
- Delivered in cloth bag

SURFLINER SURF

Model	Rod Power	Length (cm)	Sections	Lure Wt. (g)	Foregrip length	Reargrip Length (mm)	Number of Guide	Weight (g)
SFL-S-1002H	H	300	2-pcs	100-200	N/A	550	5+Tip	290
SFL-S-1103H	H	330	3-pcs	100-200	N/A	580	5+Tip	331
SFL-S-1203H	H	360	3-pcs	100-200	N/A	600	5+Tip	378
SFL-S-1303H	H	390	3-pcs	100-200	N/A	600	5+Tip	413
SFL-S-1403H	H	420	3-pcs	100-200	N/A	660	5+Tip	470
SFL-S-1403XH	XH	420	3-pcs	120-250	N/A	660	6+Tip	506
SFL-S-1503H	H	450	3-pcs	100-200	N/A	660	5+Tip	507
SFL-S-1503XH	XH	450	3-pcs	120-250	N/A	660	6+Tip	560

Wave Power

WAVE POWER RODS FEATURE:

- 24T GT blank construction
- Saltwater resistant deep press guides
- Okuma DPS plate reel seat
- Anti slip handle design



WAVE POWER

Model	Rod Power	Length (cm)	Sections	Lure Wt. (g)	Foregrip length	Reargrip Length (mm)	Number of Guide	Weight (g)
WP-S-1403H	H	420	3-pcs	100-200	N/A	670	5+Tip	585
WP-S-1403XH	XH	420	3-pcs	120-250	N/A	670	5+Tip	601
WP-S-1503H	H	450	3-pcs	100-200	N/A	670	5+Tip	617
WP-S-1503XH	XH	450	3-pcs	120-250	N/A	670	5+Tip	634

HELIOS TELE SURF

HELIOS TELE SURF RODS FEATURE:

- Fuji K-concept and Titanium guide frames
- Fuji SIC insert for braided line
- Protected in a quality guide cover
- Fuji Split reel seat with 1K woven tube
- Anti split handle design
- Screw end cap
- High quality travel bag
- Build on Toray 46T carbon material, slim, light and ultra-sensitive blanks construction



HELIOS TELE SURF

Model	Rod Power	Length (cm)	Casting Wt. (g)	Sections	Foregrip length	Reargrip Length (mm)	Number of Guide	Weight (g)
HE-S-1486MH-T	MH	440	100-200	6-Tele	N/A	670	4+TIP	388

MAKAIRA TELE SURF

MAKAIRA TELE SURF RODS FEATURE:

- 46T Toray high modulus carbon material, slim, light and ultra-sensitive blanks construction
- Dual helix carbon tape wrap configuration improved strength and durability
- Fuji KW anti tangle guides improves casting distance
- Fuji Alconite guides inserts reduce friction
- Fuji dual reel seat with spiral carbon tube body
- Durable and comfortable special handle design
- Anti-slip grip for easy put in/take off
- High quality handbag package



MAKAIRA TELE SURF

Model	Rod Power	Length (cm)	Sections	Casting Wt.(g)	Reargrip Length (mm)	Number of Guide	Weight (g)
MK-S-1486H-T	H	440	6-Tele	100-200	670	4+TIP	498

AZORES TELE SURF

AZORES RODS FEATURE:

- 40T high modulus Toray carbon blank construction
- OC-9 carbon outer wrap and solid carbon tip on tele surf rod
- Fuji deep press resistant guide frames
- Fuji Alconite insert for braided line friction
- Fuji DPS pipe reel seat
- Anti slip handle design
- High quality travel bag package



AZORES TELE SURF

Model	Rod Powers	Length (cm)	Sections	Casting Wt. (g)	Reargrip Length (mm)	Number of Guide	Weight (g)
AZ-S-1446H-T	H	430	6-Tele	100-250	670	4+Tip	473

TRIO- REX TELE SURF

TRIO-REX RODS FEATURE:

Powerful 30T carbon blank, Fuji MN frame with O-ring guide, Fuji DPS reel seat, durable and comfortable special handle design, high quality velvet cloth bag.



TRIO-REX TELE

Model	Rod Power	Length (cm)	Sections	Casting Wt. (g)	Foregrip length	Reargrip Length (mm)	Number of Guide	Weight (g)
TRX-S-1426H-T	H	425	6-Tele	100-250	N/A	675	4+TIP	532



Ceymar TELE SURF

CEYMAR TELE SURF RODS FEATURE:

- Extremely light weight and responsive 30-ton carbon blanks
- Solid carbon tip for the tele rods
- Quality deep press stainless steel frame guides
- Fuji DPS reel seat
- Non-slip handle design
- Aluminum screw end cap
- High quality cloth bag package



CEYMAR TELE SURF

Model	Rod Power	Length (cm)	Sections	Casting Wt. (g)	Foregrip Length	Reargrip Length (mm)	Number of Guide	Weight (g)
C-S-1446H-T	H	430	6-Tele	100-250	N/A	670	4+TIP	446

AVENGER TELE SURF

Powerful 24T carbon blank, Strong guide frame with super hard titanium oxide insert, FUJI reel seat, comfortable handle design, with high quality velvet cloth bag package



AVENGER TELE SURF

Model	Rod Power	Length (cm)	Sections	Casting Wt. (g)	Foregrip length	Reargrip Length (mm)	Number of Guide	Weight (g)
AV-S-1306H-T	H	390	6-Tele	100-200	N/A	680	4+Tip	424
AV-S-1406H-T	H	420	6-Tele	100-250	N/A	680	4+Tip	498

ELETTA

Surf Performance

ELETTA SURF RODS FEATURE:

- 24T and 30T carbon blank construction with solid carbon tip
- Fuji resistant guides
- Protected in a quality guide cover
- Fuji DPS pipe reel seat
- Durable shrink tube handle
- Screw end cap
- High quality travel bag



ELETTA SURF

Model	Rod Power	Length (cm)	Sections	Casting Wt. (g)	Foregrip length	Reargrip Length (mm)	Number of Guide	Weight (g)
ELT-S-1446ML-T	ML	430	6-Tele	80	N/A	660	4+TIP	394
ELT-S-1446M-T	M	430	6-Tele	100	N/A	660	4+TIP	402
ELT-S-1446MH-T	MH	430	6-Tele	120	N/A	660	4+TIP	410
ELT-S-1446H-T	H	430	6-Tele	150	N/A	660	4+TIP	448
ELT-S-1446XH-T	XH	430	6-Tele	170	N/A	660	4+TIP	483
ELT-S-1446XXH-T	XXH	430	6-Tele	200	N/A	660	4+TIP	498



REVENGER TELE SURF

REVENGER RODS FEATURE:

- High modulus carbon blank construction
- Deep press guide frames with Titanium Oxide inserts
- Protected in a quality guide cover
- Okuma branded quality reel seat
- Aluminum Screw end cap
- Supplied in quality handbag package



REVENGER TELE SURF

Model	Rod Power	Length (cm)	Sections	Casting Wt. (g)	Foregrip length	Reargrip Length (mm)	Number of Guide	Weight (g)
RV-S-1304H-T	H	390	4-Tele	100-200	N/A	660	3+TIP	456
RV-S-1404XH-T	XH	420	4-Tele	150-250	N/A	660	3+TIP	471
RV-S-1505XH-T	XH	450	5-Tele	150-250	N/A	660	4+TIP	499

FINA PRO TELE SURF

FINA PRO RODS FEATURE:

- 24T carbon ultra-responsive blank construction
- Stainless steel deep-drawn frame protect the inserts
- Polished Titanium Oxide insert for friction
- Okuma graphite reel seat
- Aluminum screw end cap with non-skid rubber
- Supplied in rod bag



FINA PRO TELE SURF

Model	Rod Power	Length (cm)	Sections	Casting Wt. (g)	Foregrip length	Reargrip Length (mm)	Number of Guide	Weight (g)
FP-S-1304H-T	H	390	4-Tele	100-200	N/A	660	3+TIP	434
FP-S-1404H-T	H	420	4-Tele	100-250	N/A	660	3+TIP	494

ALARIS TELE SURF

ALARIS TELE SURF RODS FEATURE:

- Carbon construction
- Telescopic 5 sections for fast action
- Visual white tip section
- Double legged SIC guides with rubber shock absorbers
- Okuma graphite and Alu reel seat with cushions
- Aluminum screw butt cap
- Delivered in cloth bag



ALARIS TELE SURF

Model	Rod Power	Length (cm)	Sections	Lure Wt. (g)	Reargrip Length (mm)	Number of Guide	Weight (g)
ALS-S-1305H-T	H	390	5-Tele	100-200	640	4+Tip	422
ALS-S-1405H-T	H	420	5-Tele	100-200	640	4+Tip	499



Wave Power TELE SURF

WAVE POWER TELE SURF RODS FEATURE:

- 24T GT blank construction
- Visual white tip section
- Saltwater resistant deep press guides
- Okuma DPS pipe reel seat.
- Anti slip handle design
- Alu screw butt cap



WAVE POWER TELE SURF

	Model	Rod Power	Length (cm)	Sections	Lure Wt. (g)	Reargrip Length (mm)	Number of Guide	Weight (g)
NEW	WP-S-1305MH-T	MH	390	5-Tele	80-150	650	4+Tip	422
NEW	WP-S-1305H-T	H	390	5-Tele	100-200	650	4+Tip	447
NEW	WP-S-1405MH-T	MH	420	5-Tele	80-150	650	4+Tip	460
NEW	WP-S-1405H-T	H	420	5-Tele	100-200	650	4+Tip	491





ROD /FLOAT AND REEL COMBOS

A key component of our mission at Okuma Fishing Tackle is to maintain fishing as accessible to all interested people. Part of that effort includes our involvement in numerous conservation and fishing organizations. On the product side, it's our rod and reel combos that receive the focus. Our selection is backed by our commitment to make that first step into fishing an incredibly positive experience. We fill these products with color and excitement in addition to value and performance, because catching the eye is the first step in creating an angler.

Fuel Spin

FUEL SPIN COMBOS FEATURE:

- 24T GT blank construction
- Fast action
- 3 Split EVA handle to reduce the weight and good balance
- Stainless steel frame SIC guides
- Graphite cushions reel seat
- Multi-disc, Japanese oiled felt drag washers
- 1 ball bearing drive for smoothness and durability
- Precision machine cut brass pinion gear
- Corrosion resistant graphite body and rotor
- CFR: Cyclonic Flow Rotor technology
- Machined aluminum, anodized spool
- Corrosion-resistant stainless steel bail wire
- RESII: Computer balanced Rotor Equalizing System



STEELEER XP

STEELEER XP COMBOS FEATURE:

- Durable glass fiber rod blank construction
- Feature comfortable EVA fore and rear split grip
- Multi-disc front drag washer system
- All models feature a 1 ball bearing drive system
- Reels are pre-spooled with monofilament line
- All Steeler rods are 2-pcs for easy transportation



FUEL SPIN RODS

Model	Rod Power	Line	Casting Wt. (g)	Sections	Reel Model	Bearings	Line Capacity(diameter in mm.)	Number of Guide
FSP-702L-3000	L	2.13m	5-20	2-pcs	FSP-3000	1BB	0.20/300, 0.25/200, 0.30/130	5+Tip
FSP-902L-C4000	L	2.74m	7-30	2-pcs	FSP-C4000	1BB	0.20/300, 0.25/200, 0.30/130	7+Tip

STEELEER XP COMBOS

Model	Rod Power	Rod Length	Line Weight	Lure Weight	Sections	Reel Model	Bearings	Reel Color	With Line	Line Capacity
SLXP-562-20BO	M	5' 6" / 168cm	N/A	1/8-3/8oz	2-pcs	SLXP-20	1BB	Orange	Yes	265/3, 220/4, 180/6
SLXP-562-20GR	M	5' 6" / 168cm	N/A	1/8-3/8oz	2-pcs	SLXP-20	1BB	Green	Yes	265/3, 220/4, 180/6
SLXP-562-20PK	M	5' 6" / 168cm	N/A	1/8-3/8oz	2-pcs	SLXP-20	1BB	Pink	Yes	265/3, 220/4, 180/6
SLXP-602-20BO	M	6' 0" / 183cm	N/A	1/8-3/8oz	2-pcs	SLXP-20	1BB	Orange	Yes	265/3, 220/4, 180/6
SLXP-602-20GR	M	6' 0" / 183cm	N/A	1/8-3/8oz	2-pcs	SLXP-20	1BB	Green	Yes	265/3, 220/4, 180/6
SLXP-602-20PK	M	6' 0" / 183cm	N/A	1/8-3/8oz	2-pcs	SLXP-20	1BB	Pink	Yes	265/3, 220/4, 180/6
SLXP-662-20BO	M	6' 6" / 198cm	N/A	1/8-1/2oz	2-pcs	SLXP-20	1BB	Orange	Yes	265/3, 220/4, 180/6
SLXP-662-20GR	M	6' 6" / 198cm	N/A	1/8-1/2oz	2-pcs	SLXP-20	1BB	Green	Yes	265/3, 220/4, 180/6
SLXP-662-20PK	M	6' 6" / 198cm	N/A	1/8-1/2oz	2-pcs	SLXP-20	1BB	Pink	Yes	265/3, 220/4, 180/6

CASCADE II

CASCADE II COMBOS FEATURE:

- Durable glass fiber rod blank construction
- Features comfortable EVA fore grips
- Rear grip is split configuration EVA and cork
- Multi-disc front drag washer system
- All models feature a 1 ball bearing drive system
- Reels are pre-spoiled with monofilament line
- All Cascade rods are 2-pcs for easy transportation



CASCADE II SPINNING COMBOS

Model	Rod Power	Rod Length	Line Weight	Lure Weight	Sections	Reel Model	Bearings	Reel Color	With Line	Line Capacity
CSII-502L-20	L	5' 0" / 152cm	N/A	N/A	2-pcs	CSII-20	1BB	N/A	Yes	265/3, 220/4, 180/6
CSII-562ML-20	ML	5' 6" / 168cm	N/A	N/A	2-pcs	CSII-20	1BB	N/A	Yes	265/3, 220/4, 180/6
CSII-602ML-20	ML	6' 0" / 183cm	N/A	N/A	2-pcs	CSII-20	1BB	N/A	Yes	265/3, 220/4, 180/6

SIERRA



SIERRA FLY COMBOS FEATURE:

- Light weight graphite construction
- Medium fast action
- Custom made aluminum pipe reel seat
- High quality Portuguese cork handles
- Stainless steel snake guides
- Saltwater resistant stripping guides
- Luxury velvet rod bag with a PVC tube

SIERRA FLY RODS

Model	Rod Length	Line Weight	Sections	Reel Seat Description	Rod Blank	Number of Guides	Weight (g)
SRF-904-5	9'0" / 274cm	5 Wt.	4-pcs	Special Alu Fly reel seat	24T Carbon	8+Tip	116
SRF-904-6	9'0" / 274cm	6 Wt.	4-pcs	Special Alu Fly reel seat	24T Carbon	8+Tip	118

FIN-CHASER X

FIN CHASER "X" SERIES COMBOS FEATURE:

- Durable glass fiber rod blank construction
- All models feature a comfortable EVA fore grip
- Rear grip on 6'-7' combos feature split cork
- Rear grips on 8' and larger combos is full EVA
- Multi-disc oil felt drag washers
- All models feature a 1 ball bearing drive system
- Machined aluminum, anodized spool
- Fin Chaser 8' and larger feature double foot guide construction
- All Fin Chaser rods feature 2-pcs blanks for transportation



FIN CHASER " X " SERIES COMBOS

Model	Rod Power	Rod Length	Line Weight	Lure Weight	Sections	Reel Model	Bearings	Reel Color	With Line	Line Capacity
FNX-602-30PK	ML	6' 0" / 183cm	N/A	1/8-3/8oz	2-pcs	FNX-30	1BB	Pink	Yes	310/3, 250/4, 165/6
FNX-662-30BL	M	6' 6" / 198cm	N/A	1/8-1/2oz	2-pcs	FNX-30	1BB	Blue	Yes	310/3, 250/4, 165/6
FNX-662-30YL	M	6' 6" / 198cm	N/A	1/8-1/2oz	2-pcs	FNX-30	1BB	Yellow	Yes	310/3, 250/4, 165/6
FNX-662-30PK	M	6' 6" / 198cm	N/A	1/8-1/2oz	2-pcs	FNX-30	1BB	Pink	Yes	310/3, 250/4, 165/6
FNX-70-40BL	MH	7' 0" / 213cm	N/A	1/4-3/4oz	2-pcs	FNX-40	1BB	Blue	Yes	190/10, 140/12, 110/15
FNX-70-40YL	MH	7' 0" / 213cm	N/A	1/4-3/4oz	2-pcs	FNX-40	1BB	Yellow	Yes	190/10, 140/12, 110/15
FNX-80-40BL	MH	8' 0" / 244cm	N/A	1/2-1 1/2oz	2-pcs	FNX-40	1BB	Blue	Yes	190/10, 140/12, 110/15
FNX-80-40YL	MH	8' 0" / 244cm	N/A	1/2-1 1/2oz	2-pcs	FNX-40	1BB	Yellow	Yes	190/10, 140/12, 110/15
FNX-90-60BL	MH	9' 0" / 274cm	N/A	3/4-2 1/2oz	2-pcs	FNX-60	1BB	Blue	Yes	155/18, 125/20, 90/30
FNX-90-60YL	MH	9' 0" / 274cm	N/A	3/4-2 1/2oz	2-pcs	FNX-60	1BB	Yellow	Yes	155/18, 125/20, 90/30
FNX-100-65BL	MH	10' 0" / 305cm	N/A	1-3oz	2-pcs	FNX-65	1BB	Blue	Yes	300/15, 190/20, 130/35
FNX-100-65YL	MH	10' 0" / 305cm	N/A	1-3oz	2-pcs	FNX-65	1BB	Yellow	Yes	300/15, 190/20, 130/35



F



FLY

United by single action, 1:1 retrieve ratios, our Fly, Float and Moolching products highlight two very distinct strengths of Okuma Fishing Tackle. The first is the ability of our advanced CNC machining facility in Taiwan. From the same precision factory that makes Makaira offshore reels, comes our machined float and moolching reels. The second is our commitment to value in our die-cast aluminum product lines. The Sierra fly reel changed the industry that used words like "traditional" to sell consumers grossly overpriced reels. Sierra redefined value in the fly fishing market, and SLV and Integrity products built upon that foundation. In both areas of strength, you can find bigger names, but not better product.

RAW-II 1002

RAW-1002 FLOAT REELS FEATURE:

- Precision 6061-T6 machined aluminum frame and spool
- Durable Type-II, two-tone anodized frame and spool
- 2 premium stainless steel Japanese ball bearings
- Machine cut stainless steel spool shaft
- 1-pcs Machined Rigid Frame construction
- On/Off click ratchet for added spool tension
- Ported spool with exposed rim for easy spool control
- Includes Okuma's protective neoprene reel shield
- RAWII is backed by a one year limited warranty



RAW-1002

RAW II

Model	Bearings	Weight (g)	Line Retrieve	Line capacity (yds/lbs)	Frame	Spool	Spool Width	Spool Diam.
Centerpin Float Reel								
RAW-1002	2 BB	233	13"	275/-yds / 8-lbs	AL	AL	18.5mm	114mm

AVENTA

AVENTA FLOAT REELS FEATURE:

- Precision machined stainless steel spool shafts
- 1-piece Machined Rigid Frame construction
- Machined aluminum anodized spools
- On/Off click ratchet for added spool tension
- Ported spool with exposed rim for easy control
- 2 stainless steel Japanese ball bearings



VT-1002

Float fishing is a unique and specific technique. The center-pin crowd is dedicated, knowledgeable and passionate about their sport. They are also extremely discerning about their tackle. The introduction of the Aventa center-pin sets a new standard for what can be expected in a fully-machined float reel.

The Aventa series is made from solid aluminum bar stock, for precision spool alignment and maximum freespool. The VT-1002, with two stainless steel ball bearings, is excellent for casting directly from the reel or for drag-free drifts.

AVENTA

Model	Bearings	Weight (g)	Line Retrieve	Line capacity (yds/lbs)	Frame	Spool	Spool Width	Spool Diam.
Centerpin Float Reel								
VT-1002	2 BB	233	13"	275/-yds / 8-lbs	AL	AL	18.5mm	114mm

Helios SX

HELIOS SX FLY REELS FEATURE:

- Machined aluminum and anodized frame and spool design
- Multi-disk Japanese felt drag washers provide incredible smoothness
- Hydro Block watertight drag seal protects the drag system
- 2BB + 1RB stainless steel bearing drive system
- Easy-to-change left to right hand retrieval conversion



HSX-5/6

HELIOS SX

	Model	Deag Washer	Bearings	Weight (g)	Line Retrieve	Fly line capacity	Frame	Spool	Spool Width	Spool Diam.
NEW	HSX-4/5	Felt	2BB + 1RB	153	9.6"	WF4F + 110-yds/20-lbs	AL	AL	20mm	85mm
NEW	HSX-5/6	Felt	2BB + 1RB	173	11.7"	WF5F + 150-yds/20-lbs	AL	AL	20mm	102mm
NEW	HSX-7/8	Felt	2BB + 1RB	179	12.1"	WF7F + 200-yds/20-lbs	AL	AL	25mm	105mm
NEW	HSX-8/9	Felt	2BB + 1RB	198	13.4"	WF8F + 200-yds/20-lbs	AL	AL	25mm	115mm
NEW	HSX-10/11	Felt	2BB + 1RB	218	15.3"	WF10F + 200-yds/30-lbs	AL	AL	25mm	131mm

SLV

SLV FLY REELS FEATURE:

- Lightweight graphite construction
- 4-piece rod design
- Titanium Oxide stripper guide
- Stainless steel snake guides
- Aluminum pipe reel seat with aluminum hoods
- Through-blank carbon fiber construction
- Okuma rod bag



SLV 5/6 b

SLV

	Model	Line Weight	Bearings	Weight (g)	Line Retrieve	Fly line capacity	Frame	Spool	Spool Width	Spool Diam.
	SLV 23b	2,3 wt.	1RB	128	8"	WF-2, 50yds/12lbs	AL	AL	22mm	66mm
	SLV 45b	4,5 wt.	1RB	136	9"	WF-4, 95yds/12lbs	AL	AL	24mm	75mm
	SLV 56b	5,6 wt.	1RB	150	10"	WF-5, 140yds/20lbs	AL	AL	28mm	82mm
	SLV 78b	7,8 wt.	1RB	156	11"	WF-7, 145yds/20lbs	AL	AL	31mm	88mm
	SLV 89b	8,9 wt.	1RB	173	12"	WF-8, 150yds/30lbs	AL	AL	34mm	95mm
	SLV-1011b	10,11 wt.	1RB	275	13"	WF-10, 520yds/30lbs	AL	AL	40mm	114mm
Spare spools										
	SLV 23b Spool	2,3 wt.	1RB	57	8"	WF-2, 50yds/12lbs	N/A	AL	22mm	66mm
	SLV 45b Spool	4,5 wt.	1RB	60	9"	WF-4, 95yds/12lbs	N/A	AL	24mm	75mm
	SLV 56b Spool	5,6 wt.	1RB	65	10"	WF-5, 140yds/20lbs	N/A	AL	28mm	82mm
	SLV 78b Spool	7,8 wt.	1RB	71	11"	WF-7, 145yds/20lbs	N/A	AL	31mm	88mm
	SLV 89b Spool	8,9 wt.	1RB	82	12"	WF-8, 150yds/30lbs	N/A	AL	34mm	95mm
	SLV-1011b Spool	10,11 wt.	1RB	139	13"	WF-10, 520yds/30lbs	N/A	AL	40mm	114mm



ACCESSORIES

The ultimate companion pieces to Okuma fishing rods and reels, Nomad and Okuma accessories add quality to the details of the experience. Universally, our fabrics and construction elements are top-of-the-line. The specific features are the culmination of experience and the understanding that you cannot catch fish if your gear is not in the water. Organization and accessibility are paramount. All of our accessories are built to fish hard, offering the most hard-core enthusiast a product delivers extensive pride of ownership and long-lasting durability.



Nylon Line

Japan Size	Dia./mm	Length	LB	Test Tensile (LB)	Test Strength (kg)
1.7	0.22	150M	8	8.1	3.7
2.0	0.235		9	9.0	4.1
2.5	0.26		11	11.4	5.2
3.0	0.285		13	13.4	6.1
3.5	0.31		16	15.6	7.1
4.0	0.34		17	17.4	7.9
5.0	0.37		21	21.3	9.7
6.0	0.41		25	25.3	11.5
7.0	0.44		29	29.3	13.3
8.0	0.47	33	32.8	14.9	

■ 4 Color: 30CM Purple+30CM Blue +30CM Transparent +30CM Black



Nylon Line

Japan Size	Dia./mm	LB	Test Tensile (LB)	Test Strength (kg)
1.5	0.2	7	6.8	3.1
1.7	0.21	8	7.7	3.5
2.0	0.235	9	8.8	4.0
2.5	0.26	11	10.8	4.9
3.0	0.285	13	12.5	5.7
3.5	0.31	15	14.5	6.6
4.0	0.34	17	16.5	7.5
5.0	0.37	20	20.0	9.1
6.0	0.41	24	23.8	10.8
8.0	0.47	31	31.0	14.1

■ 2 Color: 30cm Black + 150cm Orange
 ■ 2 Color: 30cm Black + 150cm White
 ■ 2 Color: 30cmM Black + 150cm Pink



ULTRA CARP NYLON LINE

Japan Size	Diameter	Test Tensile (LB)	Test Tensile (kg)
3.0	0.28	13.31	6.05
3.5	0.3	15.71	7.14
4.0	0.34	17.71	8.05
5.0	0.37	20.09	9.13
6.0	0.41	23.98	10.9
7.0	0.44	28.16	12.8
8.0	0.47	33.22	15.1
10	0.52	38.50	17.5
12	0.57	47.30	21.5



PLATINUM NYLON LINE

Diameter	Test Tensile (LB)	Test Strength (kg)
0.2	9	4
0.25	11	5.6
0.3	15	7.6
0.35	20	9.8
0.4	26.5	12.5
0.45	35	16.2
0.5	41.8	19.6
0.6	46	21
0.7	57	26.5
0.8	68	31.4
1	99	45



Carp Nylon Line

Japan Size	Dia./mm	Test Tensile (LB)	Test Strength (kg)	Length
3	0.285	5.5	12	300M
3.5	0.31	6.4	14	
4	0.34	7.7	17	
5.0	0.37	10.0	22	
6.0	0.405	11.4	25	
7.0	0.43	12.7	28	
8	0.47	13.6	30	

■ 2color : Green+Black



Sea Bass Nylon Line

Japan Size	Dia./mm	Test Tensile (LB)	Test Strength (kg)	Length
2	0.24	9.97	4.53	300M
2.5	0.26	12.52	5.69	
3	0.29	14.37	6.53	
3.5	0.31	16.98	7.72	
4	0.34	19.12	8.69	
5	0.37	21.76	9.89	
6	0.41	24.11	10.96	

■ Color : Moss green



Azul Nylon Line

No	Dia./mm	Test Tensile (LB)	Test Tensile (kg)
2	0.235	7.0	3.2
2.5	0.26	9.5	4.3
3	0.285	11.2	5.1
3.5	0.31	12.5	5.7
4	0.34	14.3	6.5
5	0.37	17.8	8.1
6	0.405	20.7	9.4
7	0.44	24.2	11
8	0.47	27.1	12.3
10	0.52	33.2	15.1



GRAND GEAR NYLON LINE

Japan Size	Diameter	Test Tensile (LB)	Test Tensile (kg)
0.6	0.13	1.58	2.27
0.8	0.15	2.29	3.28
1.0	0.17	2.99	4.29
1.2	0.19	3.81	5.43
1.5	0.21	4.47	6.38
2.0	0.24	6.97	9.97
2.5	0.26	8.76	12.52
3.0	0.29	10.05	14.15
3.5	0.31	11.04	16.98
4.0	0.34	12.43	19.12
5.0	0.37	14.15	21.96
6.0	0.41	15.66	24.11
7.0	0.44	18.11	27.85
8.0	0.47	21.23	21.67
10	0.52	27.90	42.90

■ Color : Clear Green+Black / Golden



Spinning Nylon Line

Japan Size	Dia./mm	Test Tensile (LB)	Test Strength (kg)	Length
2	0.24	9.97	4.53	300M
2.5	0.26	12.52	5.69	
3	0.29	14.37	6.53	
3.5	0.31	16.98	7.72	
4	0.34	19.12	8.69	
5	0.37	21.76	9.89	
6	0.41	24.11	10.96	

■ Color : Clear



Feeder NYLON LINE

Japan Size	Diameter	Test Tensile (LB)	Test Tensile (kg)
1.0	0.17	4.8	2.16
1.2	0.19	5.7	2.59
1.5	0.21	7.0	3.20
2.0	0.24	9.0	4.09
2.5	0.26	11.2	5.12
3.0	0.29	13.2	6.01
3.5	0.31	15.4	7.01
4.0	0.34	17.2	7.83
5.0	0.37	21.3	9.68
6.0	0.41	25.3	11.48
7.0	0.44	29.2	13.29
8.0	0.47	33.0	14.99
10	0.52	40.7	18.47



MAX POWER Nylon Line

Japan Size	Diameter	Test Tensile (LB)	Test Tensile (kg)
0.8	0.15	3.96	2.40
1.0	0.18	5.12	3.10
1.5	0.21	6.11	3.70
2.0	0.24	7.43	4.50
2.5	0.26	9.24	5.60
3.0	0.28	11.55	7.00
3.5	0.31	16.01	9.70
4.0	0.34	17.82	10.80
5.0	0.37	21.45	13.00
6.0	0.40	25.58	15.50
7.0	0.44	30.03	18.20
8.0	0.46	33.00	20.00
10	0.50	37.65	23.00



challenger Nylon Line

Japan Size	Diameter	Test Tensile (LB)	Test Tensile (kg)
1.2	0.185	3.30	4.40
1.5	0.205	4.09	5.46
2.0	0.235	6.38	8.51
2.5	0.260	7.48	10.67
3.0	0.285	8.58	12.25
3.5	0.31	10.38	14.83
4.0	0.34	11.68	16.68
5.0	0.37	13.77	19.67
6.0	0.405	16.94	24.20
7.0	0.43	18.55	26.49
8.0	0.47	21.10	30.14

■ Color : White / Neon Yellow / Neon Yellow+Orange



FLUOROCARBON LINE



SHOTAI FLUOROCARBON LINE

Japan Size	Diameter	Test Tensile (LB)	Test Tensile (kg)
0.6	0.128	3.30	1.50
0.8	0.148	4.42	2.01
1.0	0.165	5.24	2.38
1.2	0.185	5.72	2.60
1.5	0.21	7.74	3.52
1.8	0.218	9.68	4.40
2.0	0.24	10.38	4.72
2.5	0.26	12.30	5.59
3.0	0.29	14.12	6.42
4.0	0.33	16.50	7.50
5.0	0.37	20.68	9.40



SHOTAI FLUOROCARBON LINE

Japan Size	Diameter	Test Tensile (LB)	Test Tensile (kg)	LB	Meter
7	0.460	10.7	23.5	25	35M
8	0.492	13.2	29.0	30	35M
12	0.602	18.9	41.6	41	20M
16	0.696	22.4	49.3	50	20M
18	0.740	24.6	54.1	55	15M
24	0.850	31.8	70.0	70	15M
28	0.920	35.6	78.3	80	15M
35	1.020	44.9	98.8	100	15M



—
OKUMA
APPAREL



Okuma Backpack (Including 4 tackle boxes)

Model: PA247A



Okuma Motif Cotton Cap

Model: PA01C017B



Okuma Motif Mesh Cap

Model: PA01C018B



Okuma Motif Flat Peak Hat

Model: PA01C022K



Okuma Pink Cotton Cap

Model: PA01C011P



Okuma Full Back Camouflage Hat

Model: PA01C006G



Okuma Full Back Two Tone Blue Patch Hat

Model: PA01C007B



Okuma White Cotton Cap

Model: PA01C003W



FULL BRIM HAT

Model: PA01C014B

Okuma Motif Long Sleeve Shirt

UPF 50+

Size	S	M	L
Model	PA01T031BS	PA01T031BM	PA01T031BL

Size	XL	2L	3L
Model	PA01T031BXL	PA01T031B2L	PA01T031B3L



Okuma Motif Short Sleeve Shirt

UPF 50+

Size	S	M	L
Model	PA01T032BS	PA01T032BM	PA01T032BL

Size	XL	2L	3L
Model	PA01T032BXL	PA01T032B2L	PA01T032B3L



Okuma Motif Tournament Jersey

UPF 50+

Size	S	M	L
Model	PA01T030BS	PA01T030BM	PA01T030BL

Size	XL	2L	3L
Model	PA01T030BXL	PA01T030B2L	PA01T030B3L



Okuma GT Fishing Jersey

NEW

UPF 50+

Size	S	M	L
Model	PA01T048BS	PA01T048BM	PA01T048BL

Size	XL	2L	3L
Model	PA01T048BXL	PA01T048B2L	PA01T048B3L



Okuma GT Fishing Jersey

NEW

UPF 50+

Size	S	M	L
Model	PA01T049BS	PA01T049BM	PA01T049BL

Size	XL	2L	3L
Model	PA01T049BXL	PA01T049B2L	PA01T049B3L



Okuma Tuna Fishing Jersey

NEW

UPF 50+

Size	S	M	L
Model	PA01T050BS	PA01T050BM	PA01T050BL

Size	XL	2L	3L
Model	PA01T050BXL	PA01T050B2L	PA01T050B3L



Okuma Tuna Fishing Jersey NEW

UPF 50+

Size	S	M	L
Model	PA01T051BS	PA01T051BM	PA01T051BL
Size	XL	2L	3L
Model	PA01T051BXL	PA01T051B2L	PA01T051B3L



Okuma Sailfish Jersey NEW

UPF 50+

Size	S	M	L
Model	PA01T052BS	PA01T052BM	PA01T052BL
Size	XL	2L	3L
Model	PA01T052BXL	PA01T052B2L	PA01T052B3L



Okuma Dorado Long Sleeve Shirt

Size	M	L	XL
Model	PA01T036WM	PA01T036WL	PA01T036WXL
Size	2L	3L	
Model	PA01T036WM	PA01T036W3L	



Okuma Dorado Long Sleeve Shirt

Size	M	L	XL
Model	PA01T037WM	PA01T037WL	PA01T037WXL
Size	2L	3L	
Model	PA01T037W2L	PA01T037W3L	



Okuma Sailfish Jersey NEW

UPF 50+

Size	S	M	L
Model	PA01T053BS	PA01T053BM	PA01T053BL
Size	XL	2L	3L
Model	PA01T053BXL	PA01T053B2L	PA01T053B3L



Okuma Bass Jersey NEW

UPF 50+

Size	S	M	L
Model	PA01T054GS	PA01T054GM	PA01T054GL
Size	XL	2L	3L
Model	PA01T054GXL	PA01T054G2L	PA01T054G3L



Okuma Motif Cotton Short Sleeve Shirt

Size	S	M	L
Model	PA01T033BS	PA01T033BM	PA01T033BL
Size	XL	2L	3L
Model	PA01T033BXL	PA01T033B2L	PA01T033B3L



Okuma Motif Cotton Short Sleeve Shirt

Size	S	M	L
Model	PA01T033BS	PA01T033BM	PA01T033BL
Size	XL	2L	3L
Model	PA01T033BXL	PA01T033B2L	PA01T033B3L



Okuma Carp Jersey NEW

UPF 50+

Size	S	M	L
Model	PA01T055GS	PA01T055GM	PA01T055GL
Size	XL	2L	3L
Model	PA01T055GXL	PA01T055G2L	PA01T055G3L



Okuma Dorado Jersey NEW

UPF 50+

Size	S	M	L
Model	PA01T056YS	PA01T056YM	PA01T056YL
Size	XL	2L	3L
Model	PA01T056YXL	PA01T056Y2L	PA01T056Y3L



Okuma Bass Black Cotton Shirt NEW

Size	S	M	L
Model	PA01T040BS	PA01T040BM	PA01T040BL
Size	XL	2L	3L
Model	PA01T040BXL	PA01T040B2L	PA01T040B3L

Okuma Bass White Cotton Shirt NEW

Size	S	M	L
Model	PA01T040WS	PA01T040WM	PA01T040WL
Size	XL	2L	3L
Model	PA01T040WXL	PA01T040W2L	PA01T040W3L





Okuma Tuna Black Cotton Shirt NEW

Size	S	M	L
Model	PA01T041BS	PA01T041BM	PA01T041BL
Size	XL	2L	3L
Model	PA01T041BXL	PA01T041B2L	PA01T041B3L

Okuma Tuna White Cotton Shirt NEW

Size	S	M	L
Model	PA01T041WS	PA01T041WM	PA01T041WL
Size	XL	2L	3L
Model	PA01T041WXL	PA01T041W2L	PA01T041W3L



Okuma Dorado Black Cotton Shirt NEW

Size	S	M	L
Model	PA01T045BS	PA01T045BM	PA01T045BL
Size	XL	2L	3L
Model	PA01T045BXL	PA01T045B2L	PA01T045B3L

Okuma Dorado White Cotton Shirt NEW

Size	S	M	L
Model	PA01T045WS	PA01T045WM	PA01T045WL
Size	XL	2L	3L
Model	PA01T045WXL	PA01T045W2L	PA01T045W3L



Okuma Pike Black Cotton Shirt NEW

Size	S	M	L
Model	PA01T042BS	PA01T042BM	PA01T042BL
Size	XL	2L	3L
Model	PA01T042BXL	PA01T042B2L	PA01T042B3L

Okuma Pike White Cotton Shirt NEW

Size	S	M	L
Model	PA01T042WS	PA01T042WM	PA01T042WL
Size	XL	2L	3L
Model	PA01T042WXL	PA01T042W2L	PA01T042W3L



Okuma Sailfish Black Cotton Shirt NEW

Size	S	M	L
Model	PA01T046BS	PA01T046BM	PA01T046BL
Size	XL	2L	3L
Model	PA01T046BXL	PA01T046B2L	PA01T046B3L

Okuma Sailfish White Cotton Shirt NEW

Size	S	M	L
Model	PA01T046WS	PA01T046WM	PA01T046WL
Size	XL	2L	3L
Model	PA01T046WXL	PA01T046W2L	PA01T046W3L



Okuma GT Black Cotton Shirt NEW

Size	S	M	L
Model	PA01T044BS	PA01T044BM	PA01T044BL
Size	XL	2L	3L
Model	PA01T044BXL	PA01T044B2L	PA01T044B3L

Okuma GT White Cotton Shirt NEW

Size	S	M	L
Model	PA01T044WS	PA01T044WM	PA01T044WL
Size	XL	2L	3L
Model	PA01T044WXL	PA01T044W2L	PA01T044W3L



Okuma Carp Black Cotton Shirt NEW

Size	S	M	L
Model	PA01T043BS	PA01T043BM	PA01T043BL
Size	XL	2L	3L
Model	PA01T043BXL	PA01T043B2L	PA01T043B3L

Okuma GT White Cotton Shirt NEW

Size	S	M	L
Model	PA01T043WS	PA01T043WM	PA01T043WL
Size	XL	2L	3L
Model	PA01T043WXL	PA01T043W2L	PA01T043W3L

Okuma Motif Polo Shirt NEW

Size	S	M	L
Model	PA01T039BS	PA01T039BM	PA01T039BL
Size	XL	2L	3L
Model	PA01T039BXL	PA01T039B2L	PA01T039B3L



Okuma Motif Black Hoodie

Size	S	M	L
Model	PA01T034BS	PA01T034BM	PA01T034BL
Size	XL	2L	3L
Model	PA01T034BXL	PA01T034B2L	PA01T034B3L



Okuma Motif Gary Hoodie NEW

Size	2S	XS	S	M
Model	PA01T047G2S	PA01T047GXS	PA01T047GS	PA01T047GM
Size	L	XL	2L	3L
Model	PA01T047GL	PA01T047GXL	PA01T047G2L	PA01T047G3L



Okuma Motif Full-Zip Hoodie NEW

Size	S	M	L
Model	PA01J005KS	PA01J005KM	PA01J005KL
Size	XL	2L	3L
Model	PA01J005KXL	PA01J005K2L	PA01J005K3L



Okuma Ocean Waves Fishing Short NEW

Size	28	30	32	34
Model	PA01B003B28	PA01B003B30	PA01B003B32	PA01B003B34
Size	36	38	40	42
Model	PA01B003B36	PA01B003B38	PA01B003B40	PA01B003B42



Okuma Gray Fishing Short NEW

Size	28	30	32	34
Model	PA01B002G28	PA01B003B30	PA01B003B32	PA01B003B34
Size	36	38	40	42
Model	PA01B003B36	PA01B003B38	PA01B003B40	PA01B003B42



- Water-resistant, breathable, seam-sealed, 2-layer stretch shell
- 100% windproof fabric
- Attached, fully adjustable hood
- Water-resistant zip
- Adjustable cuff tabs
- Hem cinch-cord
- Reflection printing



Okuma Water Resistant Jacket

Size	S	M	L
Model	PA01J004BS	PA01J004BM	PA01J004BL
Size	XL	2L	3L
Model	PA01J004BXL	PA01J004B2L	PA01J004B3L



Okuma Motif Black Sun Shield

Model: PA01C019K



Okuma Motif Blue Sun Shield

Model: PA01C020B



Okuma Urban Shoes

Size UA	6	7	8	9	10	11	12
Size CM	24	25	26	27	28	29	30
Model	PA01H001K06	PA01H001K07	PA01H001K08	PA01H001K09	PA01H001K10	PA01H001K11	PA01H001K12

- Okuma motif design
- Lightweight and breathable woven material
- Anti-vibration EVA outsole



Okuma Motif Slipper NEW

Size UA	8	9	10	11	12
Size CM	26	27	28	29	30
Model	PA01H002K08	PA01H002K09	PA01H002K10	PA01H002K11	PA01H002K12



Okuma Motif Single Finger Casting Glove

Model: PA01F002B

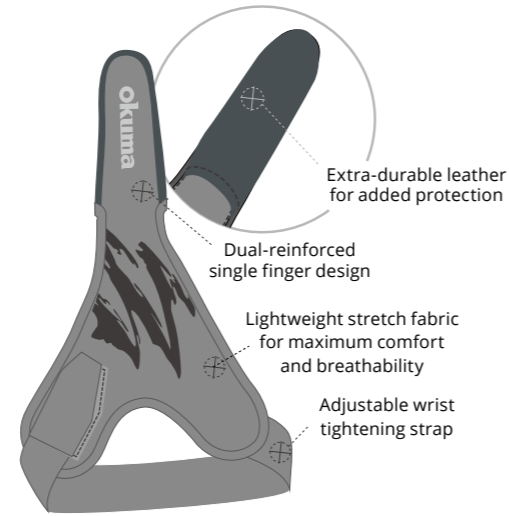

Okuma Motif Jigging Gloves

Size	XS	S	M	L	XL
Model	PA01F001WXS	PA01F001WS	PA01F001WM	PA01F001WL	PA01F001WXL

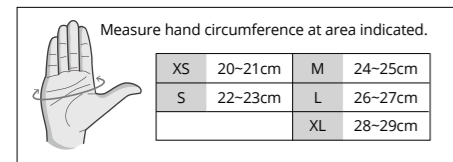

Okuma Sun Protection Fishing Glove

Size	S/M	L/XL
Model	PA01F003WM	PA01F003WXL

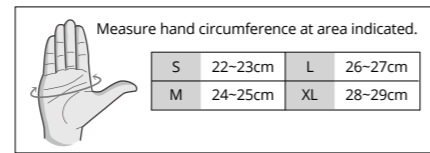

Okuma Sun glasses

Lens Color	Green Mirror	Brown	Gray
Model	PA01G001B	PA01G002B	PA01G003B



Okuma Sun glasses

Lens Color	Green Mirror	Brown	Gray
Model	PA01G004W	PA01G005W	PA01G006W



Okuma Sun glasses

Lens Color	Green Mirror	Brown	Gray
Model	PA01G007B	PA01G008B	PA01G009B



Long Nose Pliers

Type name	Long Nose Pliers 6"	Long Nose Pliers 7"
Length	6"	7"
Model	PA09028	PA09029



Split Ring Pliers

Type name	Split Ring Pliers 6"	Split Ring Pliers 9"
Length	6"	9"
Model	PA09030	PA09031



Mini Nose Pliers

Type name	Mini Nose Pliers 6"
Length	6"
Model	PA09032



Okuma Black Motif Sleeves NEW

Size	S	M	L
Model	PA01T057KS	PA01T057KM	PA01T057KL



Okuma Blue Motif Sleeves NEW

Size	S	M	L
Model	PA01T059KS	PA01T059KM	PA01T059KL



Okuma White Motif Sleeves NEW

Size	S	M	L
Model	PA01T058WS	PA01T058WM	PA01T058WL

Okuma Reel Cover

Protect your reels from unwanted dings, harsh exposure to the elements, as well as the more simple intrusions of dust and dirt. Custom Okuma neoprene reel covers are cut for a perfect fit to most star drag and lever drag reels.

Reel Shield-Neoprene Reel Cover

50/50W Lever Drag reels
Model: PAOKM0504-1

Reel Shield-Neoprene Reel Cover

20/30 size Lever Drags and 55/55W Star Drag Reels
Model: PAOKM0503-1

Reel Shield-Neoprene Reel Cover

10/15 Lever Drags and 30/40/300/450 Star Drag Reels
Model: PAOKM0502-1

Reel Shield-Neoprene Reel Cover

150/250/400 Baitcast and 15/20/200 Star Drags
Model: PAOKM0505-1



Spinning Reel Holder

Model: PA02009 (Not Including Reel)



Trolling Reel Holder

Model: PA02017 (Not Including Reel)



Okuma Lip Gripper

Model: PAFGA0201-1



Reel Shield-Neoprene Reel Cover

Model: PA409A / 40/55 Spinning Reels
Model: PA410A / 65/80 Spinning Reels



Okuma Rod Straps(L),36cm

Model: PAOKM0701-1



Okuma SPOOL BAND

Model: KSCPD07019 / S
Model: KSCPD07017 / L



Reel Display

Model: PA02007 Capacity: 28 spinning reels

Reel Display (With Security Wire)

Model: PA02016



Metal Rod Rack

Model: PA02013 Capacity: 30 rods



Bamboo Rack Capacity: 28 rods

Model: PA02014



Okuma ABS Rod Rack

Model: PAOKM1000

Simple, functional, easy to set up and easy to use. The Okuma ABS rod rack holds 8 rod and reel combos or a full 16 rods with reels removed. Connect multiple racks together to make a complete system for the largest collections.



Okuma ABS Rod Rack

Model: PA342A

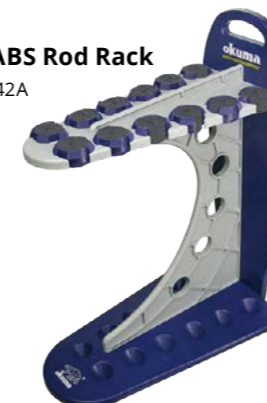

Cardboard Combo Display

Model: PA02010



Universal Reel Grease

- Maximum corrosion protection
- Fortified with teflon and polymers
- Little or no drag acceleration
- Exceptionally smooth drag performance
- Superior heat and wear resistance
- Safe on all metals and common plastics
- Reduces gear train friction for easier cranking

Accessories

Model	Dimensions
PA1139	Cal's universal drag and gear grease 30grams
PA1140	Cal's universal drag and gear grease 100grams
PA1141	Cal's universal grease 30grams with 10ML of Fishing Reel oil

